







CASEGOODS

RECEPTION BRIDGE

Series: WaveWorks

- | | |
|--------------|---|
| Aluminum: J | Recommended Tools |
| Steel: G | |
| Zinc: F |  |
| Glass: H | |
| Wood: L |  |
| Fabric: A | |
| Foam: B |  |
| Plastic 1: M | |
| Plastic 2: O |  |
| Plastic 3: K | |
| Plastic 4: I |  |
| Plastic 5: E | |
| Plastic 6: N |  |
| Plastic 7: C | |
| Plastic 9: D |  |

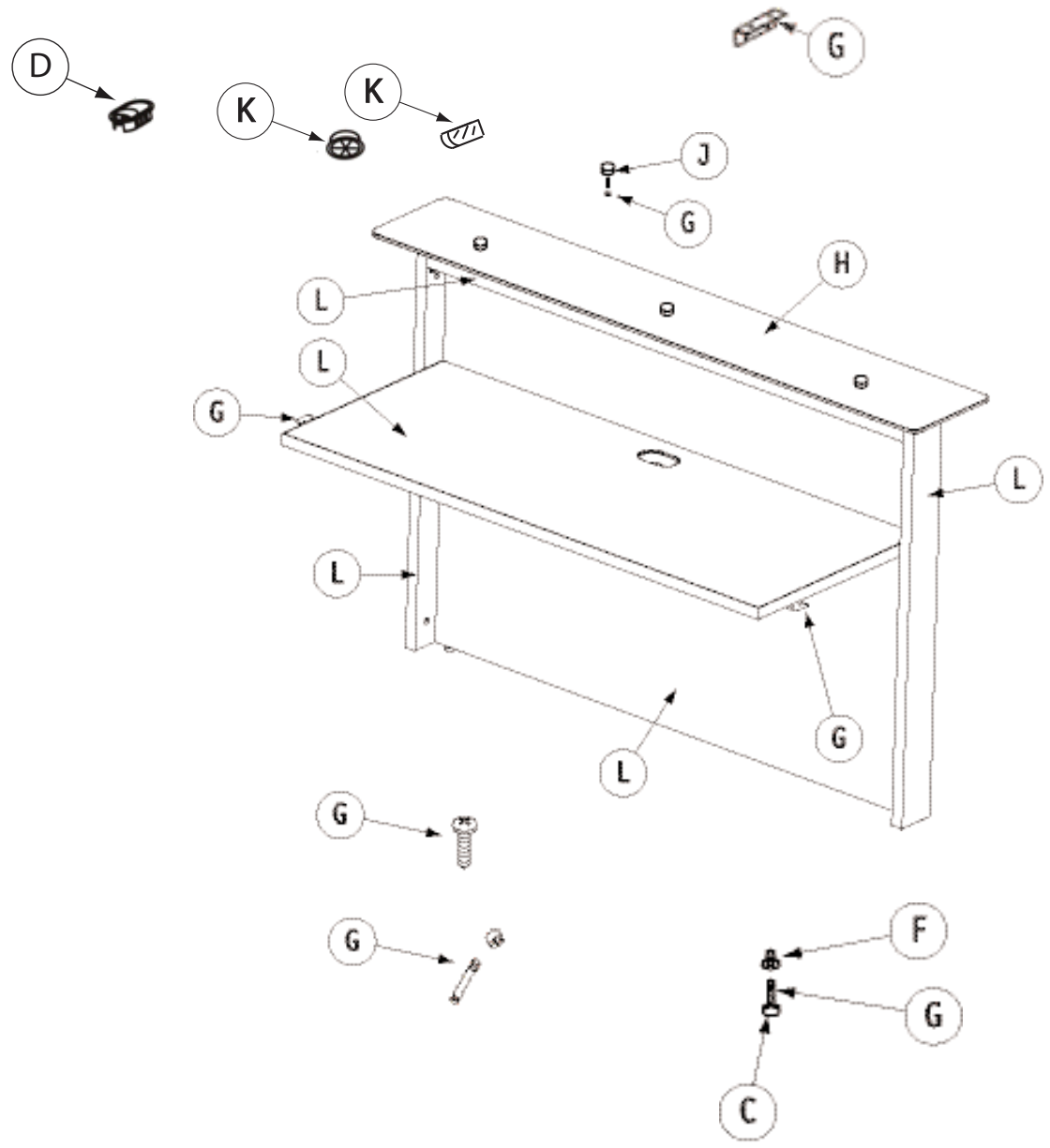

NATIONAL | Furniture with Personality

Phone 800.482.1717
 Fax 812.482.8800
www.nationalonline.com
 A Unit of Kimball International
 ©Kimball International, Inc.
 2008

Part No. 2088356