

**CLEVER SERIES  
Connector Posts and  
Arc Privacy Panel**

**Recommended Tools**  
None

Package Contents	Qty.
• Connector Posts	per order
• Arc Panels	per order

**1**

There are three types of connector posts: end, T-straight, and corner (Figure A).

**Figure A**

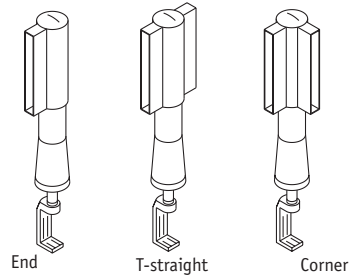

**2**

It is NOT necessary to remove grommets before installing connector posts (Figure B).

**Figure B**

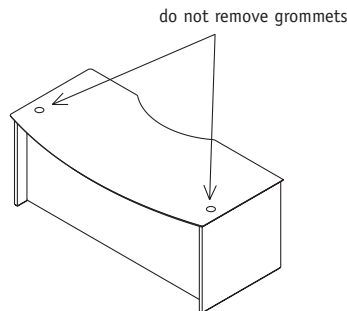

**3**

Remove the top portions of each connector post (Figure C).

**Figure C**

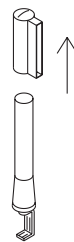

**4**

Mount the post by inserting the c-shaped clamp portion of the post through the grommet hole in the unit, making sure the clamp slips under the edge of the worksurface. Turn the main body of the post clock-wise to tighten it to the worksurface. Hand tighten only. Make sure bottom portion of post sits evenly on top of the worksurface (Figure D).

**Figure D**

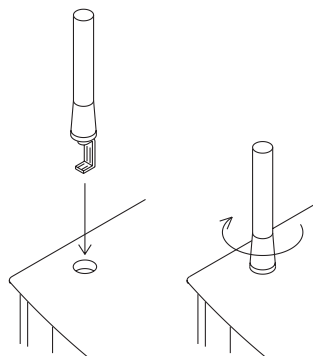

**NOTE:** It may be necessary to remove drawers from some units to make sure clamp engages properly.

**NATIONAL**  
Furniture with Personality™

Telephone 800.482.1717  
Fax 812.482.8800  
www.nationalonline.com

Form #NAICLCP  
Part #1567850

Printed in U.S.A  
© 2002 Kimball International, Inc.

Proper product installation, in accordance with these instructions, is the responsibility of the installing agent. If you have any questions concerning these instructions, please call National Customer Service.

**CLEVER SERIES**  
**Accessory Post and**  
**Arc Privacy Panel**

**5** **NOTE:** In some instances, proximity of the grommet hole to modesty panels or back panels may interfere with the clamp and could cause the post to not sit properly or be off-center.

Turn the clamp towards the outside of the unit before tightening. Make sure post sets properly in grommet hole (Figure E).

**Figure E**

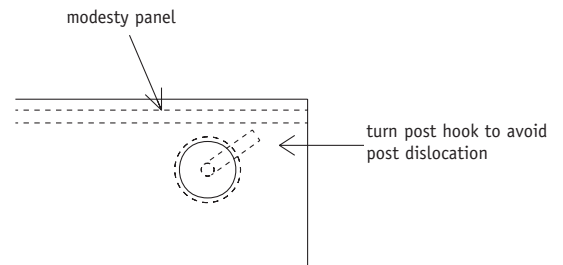

**6** Insert a top portion of each post onto each end of the arc panel to be mounted (Figure F).

**Figure F**

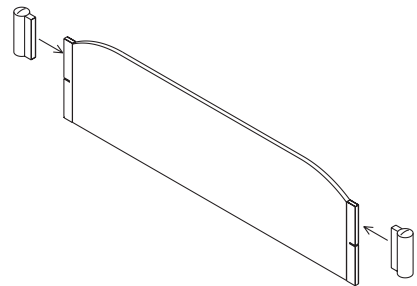

**7** Position top portions and panel assembly over the posts attached to the unit (Figure G).

**Figure G**

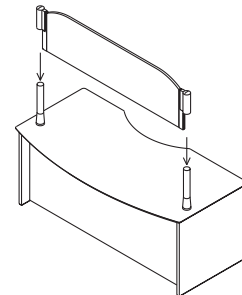

**8** Slide top portions onto posts until fully seated (Figure H).

**Figure H**

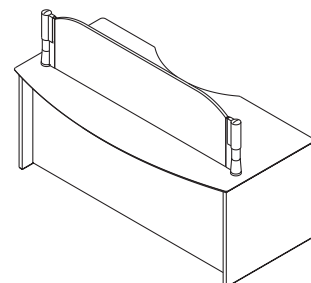

Proper product installation, in accordance with these instructions, is the responsibility of the installing agent. If you have any questions concerning these instructions, please call National Customer Service.