

1

Ganging Center Table:

Position chairs to be ganged evenly apart (approximately two feet) so that the table will be able to rest on side rails of each chair (Figure A).

Figure A

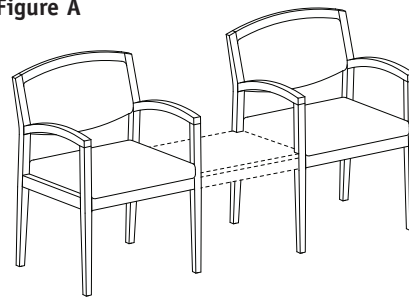

2

With angled shims on table toward rear, position table so it rests on the side rails of each chair. Squeeze chairs inward toward table for tight fit. Observe that table top is level to floor. If not, check that angled shims are toward rear of chairs (Figure B).

Figure B

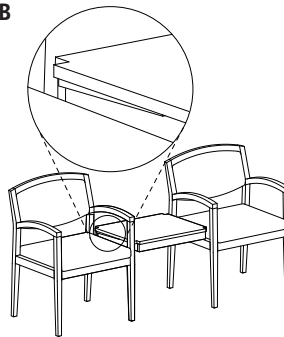

3

On one side, place two (2) U-brackets over the side rails of both chair and table.

Note: U-brackets are NOT symmetrical. When placing U-brackets, make sure holes line up on center of both table and chair rails.

Repeat for other side (Figure C).

Figure C

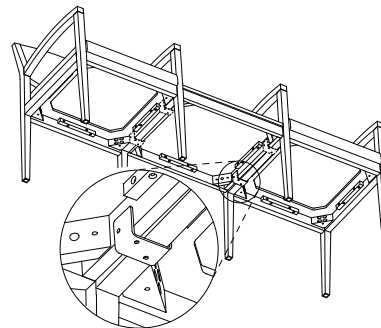

4

Using a cordless drill, insert four (4) #10 x 3/4" screws in the U-bracket (Figure D).

Figure D

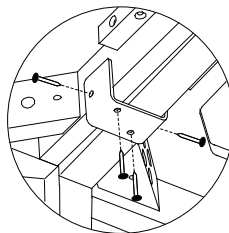

5

Repeat Step 4 to fasten remaining U-brackets.

6

After U-brackets are installed, inspect that table top is tightly secured and level with floor (Figure E).

Figure E

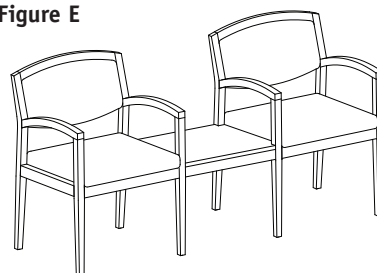

Assembly Instructions

**Eloquence™ Series
Ganging Center and
Corner Tables**

Recommended Tools

- Cordless Drill

Package Contents	Qty.
• Center/Corner Ganging Table	1
• U-Brackets	4
• #10 x 3/4" Screws	16

NATIONAL

Furniture with Personality®

Telephone 800.482.1717
Fax 812.482.8800
www.nationalonline.com

Part #2064345

Printed in U.S.A
© 2007 Kimball International, Inc.

Proper product installation, in accordance with these instructions, is the responsibility of the installing agent. If you have any questions concerning these instructions, please call National Customer Service.

SEATING

Assembly Instructions

Eloquence™ Series Ganging Center and Corner Tables

1 **Ganging Corner Table:**
Carefully uncarton and place worksurface
face down on a smooth, clean, soft surface
(Figure A).

Figure A

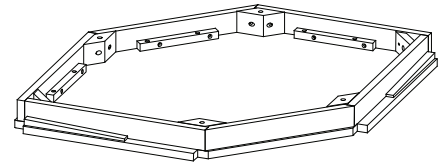

2 Remove legs from packaging and
insert threaded end of one leg into
the hole on the bottom of table.
Turn leg clockwise until tightened
(Figure B).

Figure B

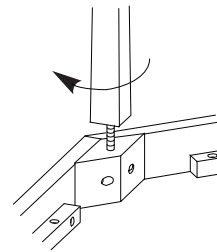

3 Repeat Step 2 to fasten remaining leg
(Figure C).

Figure C

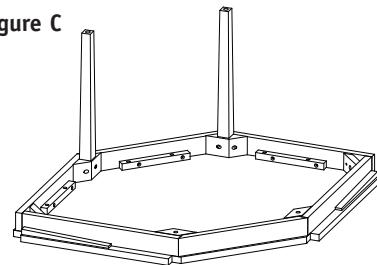

4 Position chairs (to be ganged perpendicular
to one another) facing inward and spaced
apart so that the table will be able to rest
on side rails of each chair (Figure D).

Figure D

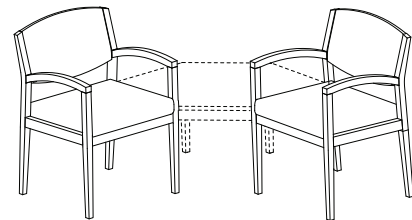

5 With legs of table aligned with back
legs of chairs, position table so it rests
on the side rails of each chair. Squeeze
chairs inward toward table for tight fit
(Figure E).

Figure E

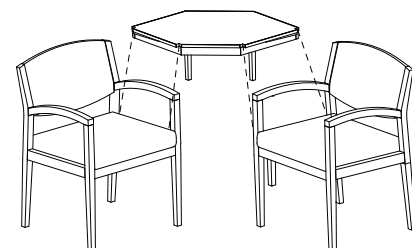

Proper product installation, in accordance with these instructions, is the responsibility of the installing agent. If you have any questions concerning these instructions, please call National Customer Service.