COLLETTE

Product Specifications	82
Fabrics and Options	83
Contrasting Fabrics Specifications	84
Product Pages	85
COM Yardage Requirements	95

COLLETTE

COLLETTE PRODUCT SPECIFICATIONS

FRAME CONSTRUCTION

- Interior frame is constructed of oriented strand board with tenon joints that are glued and stapled for maximum joint stability
- Frames and table platforms are wrapped in high grade polyurethane foam, custom shaped, fabricated, and slip-covered

SEAT CONSTRUCTION

- Seat cushions are attached to frame and feature an 8½" cushion constructed of an inner steel springcoil pack enveloped by high grade polyurethane foam

BACK CONSTRUCTION

- Back pillows are attached to back frame and feature a recycled polyester filled insert
- Back and seat cushions are attached but replaceable

ARM CONSTRUCTION

- Arms are wrapped in high grade polyurethane foam, custom shaped, fabricated and slip-covered
- Arms are connected to frame using 4 bolts per arm

UPHOLSTERY DETAILS

- Top stitch is a French seam and is offered in matching or contrasting thread colors, except on tables
- Comfort wrinkles on the seat and back cushions are an inherent part of the design
- Contrasting fabric available on all models, except tables

TABLE TOP

- Laminate surfaces are 1¾" thick HPL (high pressure laminate) and feature standard 3mm PVC edge
- Solid surfaces are 1¾" thick and feature a flat rim profile

LEGS

- Extruded aluminum square legs offered in Concrete, Cinder, Iron, Polished Aluminum, Platinum Metallic, and Satin Nickel Metallic
- Wood square legs offered in all National seating finishes
- When specifying Brighton, Sonoma, and Natural finish, variation in color is acceptable due to the nature of wood characteristics
- U-Legs offered in Concrete, Cinder, Iron, Platinum Metallic, and Satin Nickel Metallic

GLIDES

- Features 1" adjustable nylon leveling glides
- Soft/non-skid 1" adjustable glides are available for an additional upcharge

POWER AND USB GROMMET

- UL Listed
- 4-Trac® non-sequential daisy chain, hardwire, or plug solutions available
- Features 1 power outlet and 1 USB A+C combo ports
- Grommet available in black, silver, and white
- Up to 20 4-Trac grommets can be linked together
- Field installable when CUT-G35 is specified
- 4-Trac grommet must be used with 4-Trac power entry and electrical kits
- Tamper resistant and spill proof

POWER AND USB GROMMET - UNDERMOUNT

- UL Listed
- Features 1 power outlet and 2 USB (A) ports
- Only available in black
- Field installable, unit can be placed on the underside of any flat surface

TOSS PILLOWS

- Please refer to pages 527-532 under the Toss Accent Pillows section to review complementary pillow options that work well with the Collette series

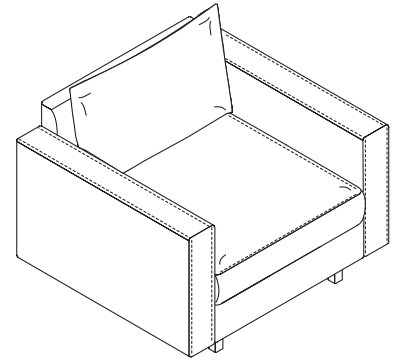

Dashed lines represent areas where matching or contrasting thread color is available

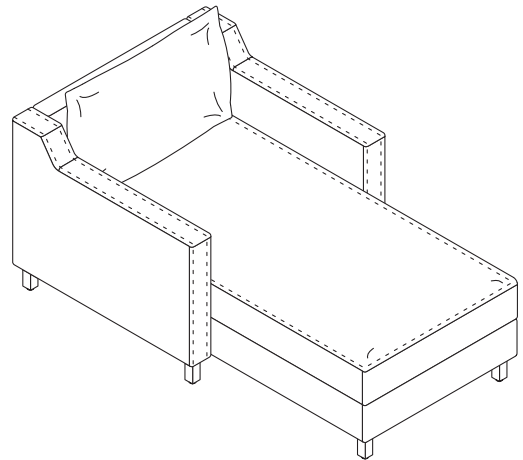

FABRICS

Grade 1	Cali
	Entwine
	Input
	Melange
	Ridge
	Spark
	Vessel
	Zig Zag

Grade 2	Bliss
	Brilliant
	COM
	Dolce
	Dorset
	Intuition
	Orbit
	Phrase
	Pixie
	Sedona
	Stencil
	Strand

Grade 4	Connect Four
	Echo
	Masquerade

Grade 5	Mode
---------	------

Grade 6	Essence/Ultraleather
---------	----------------------

Grade 7	Brisa
	Brisa Distressed
	Reef Pro
	*Silica
	*Silica Etch
	Tottori

*Silica approved colors

70909	Cumulus
70912	Ginger
70915	Quartz
70917	Alloy
70919	Haze

Grade 3	COL
	Silvertex

*Silica Etch approved colors

70701	Flint
70708	Wistful

Grade L7	Davenport
----------	-----------

Grade L8	Florence
----------	----------

SQUARE LEG COLORS

METAL

S-423	Concrete
S-462	Cinder
S-463	Iron
S-497	Polished Aluminum
S-501	Platinum Metallic
S-503	Satin Nickel Metallic

WOOD

S-WAC	Autumn
S-WAD	Almond
S-WBZ	Brazilwood
S-WCI	Chai
S-WCL	Caramel
S-WCW	Cordovan
S-WDW	Judicial
S-WHN	Honey
S-WIM	Brighton
S-WKN	Kona
S-WMC	Amber
S-WMH	Mocha
S-WNM	Natural
S-WPB	Portobello
S-WPC	Porcini
S-WPT	Portico
S-WSK	Skyline
S-WSM	Sonoma
S-WTF	Truffle
S-WWL	Willow
S-W405	Designer White
S-W462	Cinder
S-W792	Sable
S-W793	Acorn*

U-LEG COLORS

U-423	Concrete
U-462	Cinder
U-463	Iron
U-501	Platinum Metallic
U-503	Satin Nickel Metallic

GLIDES

STD	Standard
C66	Soft (add \$37 list)

THREAD COLORS

AA	Matching Thread	AW	Cool Grey
AB	White	AX	Scarlet
AC	Beige	AY	Orange
AD	Saddle	AZ	Yellow
AG	Wine	BA	Hunter
AN	Black	BB	Lime
AP	Buttercream	BC	Turquoise
AQ	Tan	BD	Light Blue
AR	Taupe	BE	Royal
AS	Brown	BF	Indigo
AT	Rust	BG	Purple
AU	Nickel	BH	Pink
AV	Grey		

LAMINATE COLORS

WOODGRAIN LAMINATE		SOLID LAMINATE	
AC2	Autumn 2	405	Designer White
AD	Almond	419	Wallaby
BZ	Brazilwood	425	Shadow
CI	Chai	440	Cloud
CL	Caramel	457	Dapple
CW	Cordovan	461	Graphite
DW	Judicial	462	Cinder
HN2	Honey 2	478	Platinum Grey
IM	Brighton	488	Frosty White
KN	Kona	491	Designer White Linear
MC	Amber	492	Cinder Linear
MH	Mocha		
NM	Natural		
PB	Portobello		
PC	Porcini		
PT	Portico		
SK	Skyline		
SM	Sonoma		
TF	Truffle		
WL	Willow		
792	Sable		
793	Acorn*		

*Acorn is the finish and laminate complement to Clear Walnut finish

POWER/USB GROMMET CUTOUT OPTIONS

If no grommet cutout is desired, specify an X (No Grommet)

\$30 list upcharge per cutout

CUT-G35L	Left
CUT-G35R	Right
CUT-G35LR	Left & Right
CUT-G35C	Center
CUT-G35LC	Left & Center
CUT-G35RC	Right & Center
CUT-G35A	Left, Right, & Center

Grommets sold separately; reference page 93 for model numbers and pricing.

SOLID SURFACE COLORS

7101	Bisque (Grade A)
7201	Glacier White (Grade A)
7202	Canyon (Grade B)
7203	Designer White (Grade B)
7204	Silt (Grade B)
7301	Concrete (Grade C)
7302	Deep Night Sky (Grade C)
7303	Deep Nocturne (Grade C)

GALLERY LAMINATE

Grade 1 – 5% upcharge	
G1001	Citadel
G1011	Pepperdust
Grade 2 – 6% upcharge	
G1002	Planked Raw Oak
G1003	Evening Notte
G1004	Kirsche
G1005	Midnight Run
G1006	Sepia Walnut
G1007	Serotina
G1008	Timeless
G1009	White Nebbia
G1012	Phantom Ecru

See page 29 for Gallery program details and upcharges

TO ORDER CONTRASTING FABRIC, SPECIFY

COLLETTE

1 Seat Lounge Square Leg page 85

Chaise Lounge Square Leg page 85

2 Seat Lounge Square Leg page 87

3 Seat Lounge Square Leg page 88

90° Inside Corner Square Leg page 88

Ottoman Square Leg page 89

1 Seat Lounge U-Leg page 90

Chaise Lounge U-Leg page 90

2 Seat Lounge U-Leg page 91

3 Seat Lounge U-Leg page 91

Ottoman U-Leg page 91

1. Model Number plus "X"
2. Back Fabric Grade Number/Cover Number
3. Seat Fabric Grade Number/Cover Number
4. Arm Fabric Grade Number/Cover Number (when applicable)
5. Upholstery Fabric Grade Number/Cover Number
6. Thread Color
7. Grommet
8. Leg Color
9. Glides

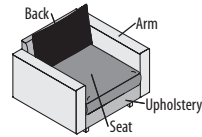

Contrasting Upholstery

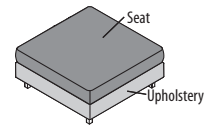

Ottoman Contrasting Upholstery

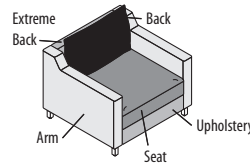

Slope Arm Contrasting Upholstery

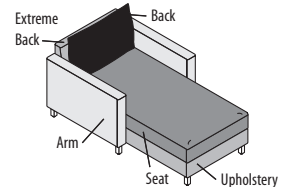

Chaise Lounge Contrasting Upholstery



Shaded models are available through our Quick Delivery program and will be delivered within 10 days or less. Shaded models that feature the 48 icon will ship within 48 hours (48). See page 8 for additional program information.

TO ORDER, SPECIFY:

1. Model Number
2. Fabric Grade / Cover Number
3. Thread Color
4. Grommet
5. Leg Color
6. Glides

- See page 83 for Collette options
- See pages 95-97 for COM fabric yardage

**1 SEAT LOUNGE
SQUARE LEG**

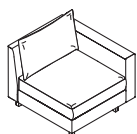

Straight Arm, Left

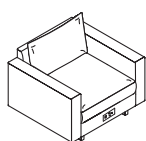

Straight Arms, Grommet

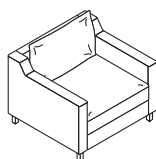

Slope Arms

**MODEL
NO.**

GRADE / LIST PRICE

		1	2/COM	3/COL	4	5	6	7	L7	L8
STRAIGHT ARM										
N84L1M	Armless	\$ 2482	2664	2744	2881	3024	3274	3605	5178	5680
QN84L1M	Armless	2482	2664	2744	2881	3024	3274	3605		
N84L1R	Straight Arm, Right	2709	2933	3031	3199	3374	3682	4088	6020	6636
N84L1L	Straight Arm, Left	2709	2933	3031	3199	3374	3682	4088	6020	6636
N84L1A	Straight Arms	2939	3205	3321	3520	3728	4093	4574	6865	7595
QN84L1A	Straight Arms	2939	3205	3321	3520	3728	4093	4574		

SLOPE ARM

N84L1RO	Slope Arm, Right	\$ 2709	2933	3031	3199	3374	3682	4088	6020	6636
N84L1LO	Slope Arm, Left	2709	2933	3031	3199	3374	3682	4088	6020	6636
N84L1AO	Slope Arms	2939	3205	3321	3520	3728	4093	4574	6865	7595

DIMENSIONS

Armless Width	30	Seat Height	18½	Arm Width		Armless Weight	66
Single Arm Width		Seat Depth	22	Straight	5½	Single Arm Weight	
Straight	35	Seat Width	30	Slope	4	Straight	84
Slope	33¾			Arm Height		Slope	82
Double Arm Width				Straight	25¼	Double Arm Weight	
Straight	40			Slope	25¼	Straight	104
Slope	37¾			Back Height	29	Slope	100
Depth	35¼					Armless Cubic Ft.	32.0
Height	34½					Single Arm Cubic Ft.	
						Straight	32.0
						Slope	30.8
						Arms Cubic Ft.	
						Straight	33.8
						Slope	34.9

- Contrasting fabric option – specify X (i.e., N84L1MX); see page 84. For list pricing, use your electronic specification tool or contact customer service
- Grommet cutout option CUT-G35C is available

COLLETTE

TO ORDER, SPECIFY:

1. Model Number
2. Fabric Grade / Cover Number
3. Thread Color
4. Grommet
5. Leg Color
6. Glides

• See page 83 for Collette options

See pages 95-97 for COM fabric yardage

**CHAISE LOUNGE
SQUARE LEG**

**MODEL
NO.**

GRADE / LIST PRICE

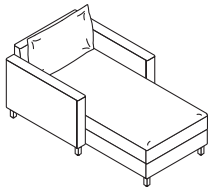

Straight Arms

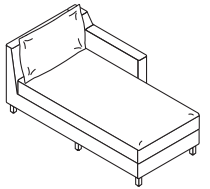

Slope Arm, Left

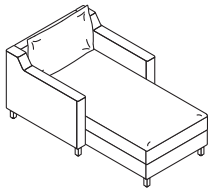

Slope Arms

		1	2/COM	3/COL	4	5	6	7	L7	L8
STRAIGHT ARM										
N84CH1M	Armless	\$ 4025	4265	4370	4550	4738	5068	5503	7573	8233
N84CH1R	Straight Arm, Right	4255	4537	4660	4871	5091	5478	5989	8417	9192
N84CH1L	Straight Arm, Left	4255	4537	4660	4871	5091	5478	5989	8417	9192
N84CH1A	Straight Arms	4485	4808	4950	5192	5445	5889	6475	9262	10151

SLOPE ARM

N84CH1RO	Slope Arm, Right	\$ 4255	4537	4660	4871	5091	5478	5989	8417	9192
N84CH1LO	Slope Arm, Left	4255	4537	4660	4871	5091	5478	5989	8417	9192
N84CH1AO	Slope Arms	4485	4808	4950	5192	5445	5889	6475	9262	10151

DIMENSIONS

Armless Width	30	Seat Height	18½	Arm Width		Armless Weight	90
Single Arm Width		Seat Depth	52½	Straight	5½	Single Arm Weight	
Straight	35	Seat Width	30	Slope	4	Straight	112
Slope	33¾			Arm Height		Slope	110
Double Arm Width				Straight	25¼	Double Arm Weight	
Straight	40			Slope	25¼	Straight	130
Slope	37¾			Back Height	29	Slope	126
Depth	66					Armless Cubic Ft.	46.8
Height	34½					Single Arm Cubic Ft.	
						Straight	54
						Slope	50.8
						Arms Cubic Ft.	
						Straight	59.5
						Slope	56.3

- Contrasting fabric option – specify X (i.e., N84CH1AX); see page 84. For list pricing, use your electronic specification tool or contact customer service
- Grommet cutout option CUT-G35C is available



Shaded models are available through our Quick Delivery program and will be delivered within 10 days or less. Shaded models that feature the 48 icon will ship within 48 hours (48). See page 8 for additional program information.

TO ORDER, SPECIFY:

1. Model Number
2. Fabric Grade / Cover Number
3. Thread Color
4. Grommet
5. Leg Color
6. Glides

- See page 83 for Collette options
- See pages 95-97 for COM fabric yardage

2 SEAT LOUNGE SQUARE LEG

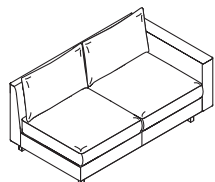

Straight Arm, Left

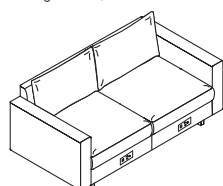

Straight Arms, Grommets

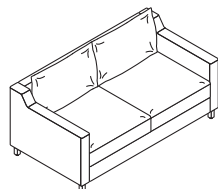

Slope Arms

MODEL NO.

GRADE / LIST PRICE

		1	2/COM	3/COL	4	5	6	7	L7	L8
STRAIGHT ARM										
N84L2M	Armless	\$ 3984	4326	4476	4733	5001	5471	6092	9045	9987
QN84L2M	Armless	3984	4326	4476	4733	5001	5471	6092		
N84L2R	Straight Arm, Right	4211	4595	4763	5051	5351	5879	6575	9887	10943
N84L2L	Straight Arm, Left	4211	4595	4763	5051	5351	5879	6575	9887	10943
N84L2A	Straight Arms	4440	4866	5052	5371	5704	6289	7060	10731	11901
QN84L2A	Straight Arms	4440	4866	5052	5371	5704	6289	7060		

SLOPE ARM

N84L2RO	Slope Arm, Right	\$ 4211	4595	4763	5051	5351	5879	6575	9887	10943
N84L2LO	Slope Arm, Left	4211	4595	4763	5051	5351	5879	6575	9887	10943
N84L2AO	Slope Arms	4440	4866	5052	5371	5704	6289	7060	10731	11901

DIMENSIONS

Armless Width	60	Seat Height	18½	Arm Width		Armless Weight	137
Single Arm Width		Seat Depth	22	Straight	5½	Single Arm Weight	
Straight	65	Seat Width	60	Slope	4	Straight	155
Slope	63¾			Arm Height		Slope	153
Double Arm Width				Straight	25¼	Double Arm Weight	
Straight	70			Slope	25¼	Straight	165
Slope	67¾			Back Height	29	Slope	161
Depth	35¼					Armless Cubic Ft.	56.6
Height	34½					Single Arm Cubic Ft.	
						Straight	56.6
						Slope	55.5
						Arms Cubic Ft.	
						Straight	50.9
						Slope	59.6

- Contrasting fabric option – specify X (i.e., N84L2MX); see page 84. For list pricing, use your electronic specification tool or contact customer service
- Grommet cutout options CUT-G35L, CUT-G35R, CUT-G35LR are available

COLLETTE



Shaded models are available through our Quick Delivery program and will be delivered within 10 days or less. Shaded models that feature the 48 icon will ship within 48 hours (48). See page 8 for additional program information.

TO ORDER, SPECIFY:

1. Model Number
2. Fabric Grade / Cover Number
3. Thread Color
4. Grommet
5. Leg Color
6. Glides

• See page 83 for Collette options

See pages 95-97 for COM fabric yardage

3 SEAT LOUNGE SQUARE LEG

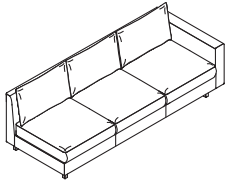

Straight Arm, Left

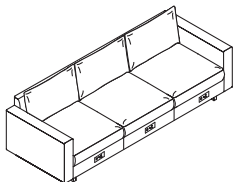

Straight Arms, Grommets

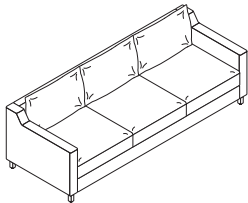

Slope Arms

MODEL NO.

GRADE / LIST PRICE

		1	2/COM	3/COL	4	5	6	7	L7	L8
STRAIGHT ARM										
N84L3M	Armless	\$ 5420	5922	6142	6519	6912	7602	8513	12846	14228
QN84L3M	Armless	5420	5922	6142	6519	6912	7602	8513		
N84L3R	Straight Arm, Right	5649	6193	6431	6839	7264	8012	8998	13690	15186
N84L3L	Straight Arm, Left	5649	6193	6431	6839	7264	8012	8998	13690	15186
N84L3A	Straight Arms	5877	6463	6719	7158	7616	8421	9482	14533	16143
QN84L3A	Straight Arms	5877	6463	6719	7158	7616	8421	9482		

SLOPE ARM

N84L3RO	Slope Arm, Right	\$ 5649	6193	6431	6839	7264	8012	8998	13690	15186
N84L3LO	Slope Arm, Left	5649	6193	6431	6839	7264	8012	8998	13690	15186
N84L3AO	Slope Arms	5877	6463	6719	7158	7616	8421	9482	14533	16143

DIMENSIONS

Armless Width	90	Seat Height	18½	Arm Width		Armless Weight	188
Single Arm Width		Seat Depth	22	Straight	5½	Single Arm Weight	
Straight	95	Seat Width	90	Slope	4	Straight	206
Slope	93¾			Arm Height		Slope	204
Double Arm Width				Straight	25¼	Double Arm Weight	
Straight	100			Slope	25¼	Straight	225
Slope	97¾			Back Height	29	Slope	221
Depth	35¼					Armless Cubic Ft.	68.5
Height	34½					Single Arm Cubic Ft.	
						Straight	80.2
						Slope	80.2
						Arms Cubic Ft.	
						Straight	84.4
						Slope	84.4

- Contrasting fabric option – specify X (i.e., N84L3MX); see page 84. For list pricing, use your electronic specification tool or contact customer service
- All grommet cutout options are available

90° INSIDE CORNER SQUARE LEG



Left, Grommet

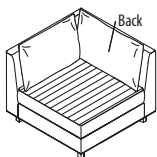

Right

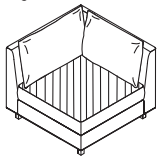

Diagonal

		1	2/COM	3/COL	4	5	6	7	L7	L8
N84IN9L	90° Inside Corner Left, Square Leg	\$ 2874	3130	3242	3434	3634	3986	4450	6658	7362
N84IN9R	90° Inside Corner Right, Square Leg	2874	3130	3242	3434	3634	3986	4450	6658	7362
N84IN9D	90° Inside Corner Diagonal, Square Leg	2874	3143	3260	3462	3672	4042	4529	6847	7586

DIMENSIONS

Width	35¼	Seat Height	18½	Back Height	29	Weight	86
Depth	35¼	Seat Depth	22			Cubic Ft.	32.0
Height	34½	Seat Width	22				

- Contrasting fabric option – specify X (i.e., N84IN9LX); see page 84. For list pricing, use your electronic specification tool or contact customer service
- Grommet cutout options CUT-G35L and CUT-G35R are available



Shaded models are available through our Quick Delivery program and will be delivered within 10 days or less. Shaded models that feature the 48 icon will ship within 48 hours (48). See page 8 for additional program information.

TO ORDER, SPECIFY:

1. Model Number
2. Laminate (when applicable)
3. Solid Surface Grade/Color (when applicable)
4. Fabric Grade / Cover Number
5. Thread Color (when applicable)
6. Leg Color
7. Grommet
8. Glides

• See page 83 for Collette options
See pages 95-97 for COM fabric yardage

OTTOMAN SQUARE LEG

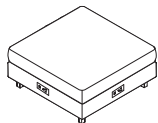

Grommets

MODEL NO.	GRADE / LIST PRICE										
		1	2/COM	3/COL	4	5	6	7	L7	L8	
N84D1	Ottoman, 30", Square Leg	\$ 1633	1739	1785	1864	1947	2092	2283	3194	3484	
QN84D1	Ottoman, 30", Square Leg	1633	1739	1785	1864	1947	2092	2283			
N84D2	Ottoman, 36", Square Leg	2037	2149	2198	2282	2370	2524	2727	3693	4001	
QN84D2	Ottoman, 36", Square Leg	2037	2149	2198	2282	2370	2524	2727			

30" DIMENSIONS		36" DIMENSIONS	
Width	30	Width	35¼
Depth	30	Depth	35¼
Height	18½	Height	18½
Weight	52	Weight	78
Cubic Ft.	12.2	Cubic Ft.	17.3

- Contrasting fabric option – specify X (i.e., N84D1X); see page 84. For list pricing, use your electronic specification tool or contact customer service
- All grommet cutout options are available

END TABLE SQUARE LEG

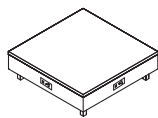

Grommets

		1	2/COM	3/COL	4	5	6	7	L7	L8
N84T36ENL	Laminate Top, Square Leg	\$ 1274	1316	1334	1365	1398	1455	1530	1889	2003
N84T36ENS	Solid Surface Top, Grade A, Square Leg	3069	3111	3129	3160	3193	3250	3325	3684	3798

DIMENSIONS			
Width	35¼	Weight	94
Depth	35¼	Weight - Solid Surface	125
Height	11½	Cubic Ft.	17.3

- Solid Surface Grades B and C list pricing – use your electronic specification tool or contact customer service
- All grommet cutout options are available

MAGAZINE TABLE SQUARE LEG

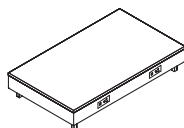

Grommets

		1	2/COM	3/COL	4	5	6	7	L7	L8
N84T60MGL	Laminate Top, Square Leg	\$ 2351	2412	2438	2484	2532	2615	2725	3250	3417
N84T60MGS	Solid Surface Top, Grade A, Square Leg	5617	5678	5704	5750	5798	5881	5991	6516	6683

DIMENSIONS			
Width	60	Weight	151
Depth	35¼	Weight - Solid Surface	202
Height	11½	Cubic Ft.	26.0

- Solid Surface Grades B and C list pricing – use your electronic specification tool or contact customer service
- Grommet cutout options CUT-G35L, CUT-G35R, CUT-G35LR are available

COLLETTE

TO ORDER, SPECIFY:

1. Model Number
2. Fabric Grade / Cover Number
3. Thread Color
4. Grommet
5. Leg Color
6. Glides

• See page 83 for Collette options

See pages 95-97 for COM fabric yardage

**1 SEAT LOUNGE
U-LEG**

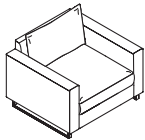

Straight Arms

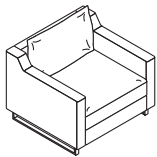

Slope Arm

**MODEL
NO.**

GRADE / LIST PRICE

		1	2/COM	3/COL	4	5	6	7	L7	L8
N84L1UM	Armless	\$ 2827	3009	3089	3226	3369	3619	3950	5523	6025
N84L1UA	Straight Arms	3265	3531	3647	3846	4054	4419	4900	7191	7921
N84L1UAO	Slope Arms	3265	3531	3647	3846	4054	4419	4900	7191	7921

DIMENSIONS

Armless Width	30	Seat Height	18½	Arm Width		Armless Weight	69
Single Arm Width		Seat Depth	22	Straight	5%	Double Arm Weight	
Straight	40	Seat Width	30	Slope	4	Straight	110
Slope	33¾			Arm Height		Slope	106
Depth	35¼			Straight	25¼	Armless Cubic Ft.	32
Height	34½			Slope	25¼	Arms Cubic Ft.	
				Back Height	29	Straight	33.8

- Contrasting fabric option – specify X (i.e., N84L1UAX); see page 84. For list pricing, use your electronic specification tool or contact customer service
- Grommet cutout option CUT-G35C is available

**CHAISE LOUNGE
U-LEG**

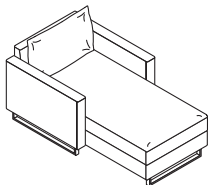

Straight Arms

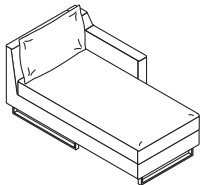

Slope Arm, Left

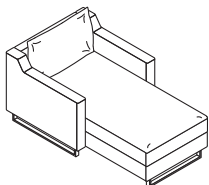

Slope Arms

		1	2/COM	3/COL	4	5	6	7	L7	L8
--	--	---	-------	-------	---	---	---	---	----	----

STRAIGHT ARM

N84CH1UM	Armless	\$ 4350	4590	4695	4875	5063	5393	5828	7898	8558
N84CH1UR	Straight Arm, Right	4580	4862	4985	5196	5416	5803	6314	8742	9517
N84CH1UL	Straight Arm, Left	4580	4862	4985	5196	5416	5803	6314	8742	9517
N84CH1UA	Straight Arms	4810	5133	5275	5517	5770	6214	6800	9587	10476

SLOPE ARM

N84CH1URO	Slope Arm, Right	\$ 4580	4862	4985	5196	5416	5803	6314	8742	9517
N84CH1ULO	Slope Arm, Left	4580	4862	4985	5196	5416	5803	6314	8742	9517
N84CH1UAO	Slope Arms	4810	5133	5275	5517	5770	6214	6800	9587	10476

DIMENSIONS

Armless Width	30	Seat Height	18½	Arm Width		Armless Weight	97
Single Arm Width		Seat Depth	52½	Straight	5%	Single Arm Weight	
Straight	35	Seat Width	30	Slope	4	Straight	117
Slope	33¾			Arm Height		Slope	115
Double Arm Width				Straight	25¼	Double Arm Weight	
Straight	40			Slope	25¼	Straight	134
Slope	37¾			Back Height	29	Slope	130
Depth	66					Armless Cubic Ft.	46.8
Height	34½					Single Arm Cubic Ft.	
						Straight	54
						Slope	50.8
						Arms Cubic Ft.	
						Straight	59.5
						Slope	56.3

- Contrasting fabric option – specify X (i.e., N84CH1UAX); see page 84. For list pricing, use your electronic specification tool or contact customer service
- Grommet cutout option CUT-G35C is available

TO ORDER, SPECIFY:

1. Model Number
2. Fabric Grade / Cover Number
3. Thread Color
4. Grommet
5. Leg Color
6. Glides

• See page 83 for Collette options
See pages 95-97 for COM fabric yardage

**2 SEAT LOUNGE
U-LEG**

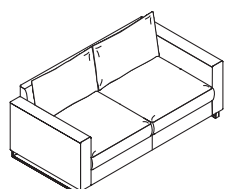

Straight Arms

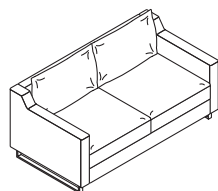

Slope Arms

MODEL NO.	GRADE / LIST PRICE										
		1	2/COM	3/COL	4	5	6	7	L7	L8	
N84L2UM	Armless	\$ 3732	4074	4224	4481	4749	5219	5840	8793	9735	
N84L2UA	Straight Arms	4767	5193	5379	5698	6031	6616	7387	11058	12228	
N84L2UAO	Slope Arms	4767	5193	5379	5698	6031	6616	7387	11058	12228	

DIMENSIONS

Armless Width	30	Seat Height	18½	Arm Width		Armless Weight	140
Double Arm Width		Seat Depth	22	Straight	5½	Double Arm Weight	
Straight	70	Seat Width	60	Slope	4	Straight	171
Slope	37¼			Arm Height		Slope	167
Depth	35¼			Straight	25¼	Armless Cubic Ft.	56.6
Height	34½			Slope	25¼	Arms Cubic Ft.	
				Back Height	29	Straight	50.9

- Contrasting fabric option – specify X (i.e., N84L2UAX); see page 84. For list pricing, use your electronic specification tool or contact customer service
- Grommet cutout options CUT-G35L, CUT-G35R, CUT-G35LR are available

**3 SEAT LOUNGE
U-LEG**

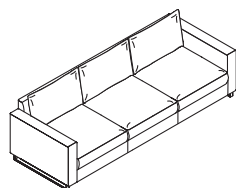

Straight Arms

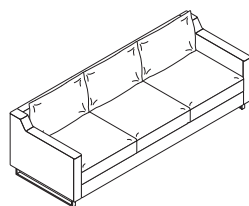

Slope Arms

MODEL NO.	GRADE / LIST PRICE										
		1	2/COM	3/COL	4	5	6	7	L7	L8	
N84L3UM	Armless	\$ 5169	5671	5891	6268	6661	7351	8262	12595	13977	
N84L3UA	Straight Arms	6204	6790	7046	7485	7943	8748	9809	14860	16470	
N84L3UAO	Slope Arms	6204	6790	7046	7485	7943	8748	9809	14860	16470	

DIMENSIONS

Armless Width	90	Seat Height	18½	Arm Width		Armless Weight	191
Double Arm Width		Seat Depth	22	Straight	5½	Double Arm Weight	
Straight	100	Seat Width	90	Slope	4	Straight	231
Slope	37¼			Arm Height		Slope	227
Depth	35¼			Straight	25¼	Armless Cubic Ft.	68.5
Height	34½			Slope	25¼	Arms Cubic Ft.	
				Back Height	29	Straight	84.4

- Contrasting fabric option – specify X (i.e., N84L3UAX); see page 84. For list pricing, use your electronic specification tool or contact customer service
- All grommet cutout options are available

**OTTOMAN
U-LEG**

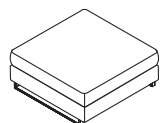

MODEL NO.	GRADE / LIST PRICE										
		1	2/COM	3/COL	4	5	6	7	L7	L8	
N84D1U	Ottoman, 30", U-Leg	\$ 1893	1999	2045	2124	2207	2352	2543	3454	3744	
N84D2U	Ottoman, 36", U-Leg	2363	2475	2524	2608	2696	2850	3053	4019	4327	

30" DIMENSIONS

Width	30
Depth	30
Height	18½
Weight	58
Cubic Ft.	12.2

36" DIMENSIONS

Width	35¼
Depth	35¼
Height	18½
Weight	84
Cubic Ft.	17.3

- Contrasting fabric option – specify X (i.e., N84D1UX); see page 84. For list pricing, use your electronic specification tool or contact customer service
- All grommet cutout options are available

COLLETTE

TO ORDER, SPECIFY:

1. Model Number
2. Laminate (when applicable)
3. Solid Surface Grade/Color (when applicable)
4. Fabric Grade / Cover Number
5. Leg Color
6. Grommet
7. Glides

• See page 83 for Collette options

See pages 95-97 for COM fabric yardage

**END TABLE
U-LEG**

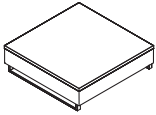

**MODEL
NO.**

GRADE / LIST PRICE

		1	2/COM	3/COL	4	5	6	7	L7	L8
N84T36ENUL	Laminate Top, U-Leg	\$ 1535	1577	1595	1626	1659	1716	1791	2150	2264
N84T36ENUS	Solid Surface Top, Grade A, U-Leg	3396	3438	3456	3487	3520	3577	3652	4011	4125

DIMENSIONS

Width	35¼								Weight	94
Depth	35¼								Weight - Solid Surface	125
Height	11½								Cubic Ft.	17.3

- Solid Surface Grades B and C list pricing – use your electronic specification tool or contact customer service
- All grommet cutout options are available

**MAGAZINE TABLE
U-LEG**

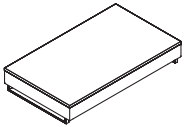

		1	2/COM	3/COL	4	5	6	7	L7	L8
N84T60MGUL	Laminate Top, U-Leg	\$ 2677	2738	2764	2810	2858	2941	3051	3576	3743
N84T60MGUS	Solid Surface Top, Grade A, U-Leg	5942	6003	6029	6075	6123	6206	6316	6841	7008

DIMENSIONS

Width	60								Weight	151
Depth	35¼								Weight - Solid Surface	202
Height	11½								Cubic Ft.	26.0

- Solid Surface Grades B and C list pricing – use your electronic specification tool or contact customer service
- Grommet cutout options CUT-G35L, CUT-G35R, CUT-G35LR are available

TO ORDER, SPECIFY:

• See page 83 for Collette options

1. Model Number

POWER/USB GROMMET - PLUGGED

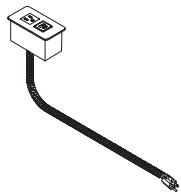

MODEL NO.		LIST PRICE	CARTONED WEIGHT	CUBIC FEET
NACG35AELPGB	Black	\$ 536	1.5 lbs.	0.3
NACG35AELPGS	Silver	536	1.5 lbs.	0.3
NACG35AELPGW	White	536	1.5 lbs.	0.3

- Features 1 power outlet and 1 USB (A+C) combo ports
- Includes black 72" long 3-prong power cord
- Power outlet provides 15 amps

POWER/USB GROMMET HARDWIRE

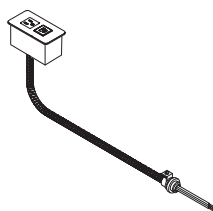

NACG35AELHCB	Hardwire, Black	\$ 620	1.75 lbs.	0.3
NACG35AELHCS	Hardwire, Silver	620	1.75 lbs.	0.3
NACG35AELHCW	Hardwire, White	620	1.75 lbs.	0.3

- Features 1 power outlet and 1 USB (A+C) combo ports
- Metal conduit hardwire is 72" long
- Power outlet provides 15 amps

POWER/USB GROMMET 4-TRAC

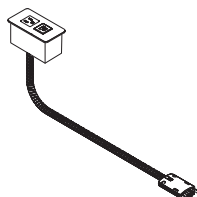

NACG35AELPDB	Black	\$ 551	2.0 lbs.	0.3
NACG35AELPDS	Silver	551	2.0 lbs.	0.3
NACG35AELPDW	White	551	2.0 lbs.	0.3

- Non-sequential daisy chain solution
- Must use with power entry and electrical kit
- Features 1 power outlet and 1 USB (A+C) combo ports
- 36" long cord
- Up to 20 grommets can be linked together for each power entry

POWER ENTRY 4-TRAC



Plug View

NAC72ELE4H	72" Hardwire	\$ 183	1.95 lbs.	0.38
NAC48ELE4P	48" Plug	266	1.95 lbs.	0.38
NAC72ELE4P	72" Plug	300	1.95 lbs.	0.38

- Must be ordered with 4-Trac electrical kit and 4-Trac power/USB grommet
- 1 power entry is necessary to power 1 or multiple units
- Power entry provides 20 amps

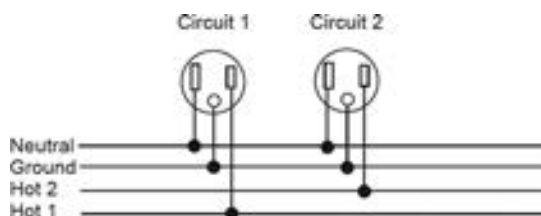

COLLETTE



Shaded models are available through our Quick Delivery program and will be delivered within 10 days or less. Shaded models that feature the 48 icon will ship within 48 hours (48). See page 8 for additional program information.

TO ORDER, SPECIFY:

• See page 83 for Collette options

1. Model Number

**ELECTRICAL KITS
4-TRAC**

MODEL NO.		LIST PRICE	CARTONED WEIGHT	CUBIC FEET
NACEL4KTA1	1 H-Block, 42" Jumper Male / Male End	\$ 127	1.36 lbs.	0.38
NACEL4KTA2	2 - H-Block 1 - 42" Jumper Male / Male End 1 - 20" Jumper Male / Male End	238	2.34 lbs.	0.38
NACEL4KTA3	3 - H-Block 2 - 42" Jumper Male / Male End 1 - 20" Jumper Male / Male End	336	3.20 lbs.	0.38

• Use specification guide below to determine the appropriate electrical kit for each unit

ELECTRICAL KIT SPECIFICATION GUIDE

COMPONENT	FOR POWER OPTION, SPECIFY:	FOR PASS THRU OPTION (NON-POWER UNITS), SPECIFY:
1 Seat	NACEL4KTA1	NACEL4KTA1
2 Seat	NACEL4KTA2	NACEL4KTA2
3 Seat	NACEL4KTA3	NACEL4KTA3
Corner	NACEL4KTA1	NACEL4KTA1
Ottoman	NACEL4KTA1	NACEL4KTA1
End Table	NACEL4KTA1	NACEL4KTA1
Magazine Table	NACEL4KTA2	NACEL4KTA2

4-Trac electrical kits are only needed if units with electrical are being ganged

**UNDERMOUNT
USB POWER UNIT**

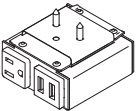

NAC03ELUPDC	Black only	\$ 346	2 lbs.	0.3
-------------	------------	--------	--------	-----

DIMENSIONS

Width	3
Depth	3
Height	1½

- Can be mounted to the underside of any flat surface
- Features 1 power outlet and 2 USB (A) ports
- 72" 15 amp cord

GANGING BRACKET

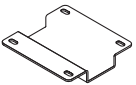

Ganging Bracket Kit

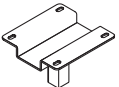

Leg Ganging Bracket Kit

N84GK	Ganging Bracket Kit (2 Brackets)	\$ 112	2.5 lbs.	0.2
N84GKL	Leg Ganging Bracket Kit (2 Brackets With Legs)	190	3.0 lbs.	0.2
N84GKAL	Large Leg Ganging Bracket Kit (2 Brackets With Legs)	253	3.0 lbs.	0.2

- Ganging bracket kit includes required brackets to join 2 units together
- Leg ganging bracket kit allows the removal of front and back legs when ganging 2 units
- Large leg ganging bracket kit for intermediate arm ganging
- All bracket models provide wire management

COM YARDAGE REQUIREMENTS (54" WIDTH – CUT UP THE ROLL)

MODEL	RAILROADED Contact customer service 800-482-1717 for ydg requirements	NON DIRECTIONAL OR SOLID	1"-4" REPEAT	5"-11" REPEAT	12"-18" REPEAT	COL SQUARE FEET
			4" VERTICAL X 4" HORIZONTAL	11" VERTICAL X 11" HORIZONTAL	18" VERTICAL X 18" HORIZONTAL	
N84L1A, N84L1AO, N81UAO		8.30	8.90	12.20	14.70	165
N84L1AX, N84L1AOX, N81L1UAOX	Upholstery	2.40	2.90	4.20	4.70	47
	Seat	2.10	2.70	4.60	5.70	41
	Back	1.30	1.60	2.20	3.30	26
	Arm	2.60	3.20	3.90	7.50	52
N84L1UA		8.30	8.90	12.20	14.70	165
N84L1UAX	Upholstery	2.40	2.90	4.20	4.70	47
	Seat	2.10	2.70	4.60	5.70	41
	Back	1.30	1.60	2.20	3.30	26
	Arm	2.60	3.20	3.90	7.50	52
N84L1L, N84L1LO		7.00	7.80	10.80	13.20	139
N84L1LX, N84L1LOX	Upholstery	2.40	2.90	4.20	4.70	47
	Seat	2.10	2.90	4.20	4.70	47
	Back	1.30	1.60	2.20	3.30	26
	Arm	1.30	1.70	2.50	4.50	27
N84L1R, N84L1RO		7.00	7.50	10.80	13.20	138
N84L1RX, N84L1ROX	Upholstery	2.40	2.90	4.20	4.70	47
	Seat	2.10	2.70	2.70	5.70	41
	Back	1.30	1.60	2.20	3.30	26
	Arm	1.30	1.70	2.50	4.50	27
N84L1M		5.70	6.60	9.40	10.70	39
N84L1MX	Upholstery	2.40	2.90	4.20	4.70	47
	Seat	2.10	2.70	4.60	5.70	41
	Back	1.30	1.60	2.20	3.30	26
N84L1UM		5.70	6.60	9.40	10.70	39
N84L1UMX	Upholstery	2.40	2.90	4.20	4.70	47
	Seat	2.10	2.70	4.60	5.70	41
	Back	1.30	1.60	2.20	3.30	26
N84L2A, N84L2AO		13.30	14.70	19.70	23.20	266
N84L2AX, N84L2AOX	Upholstery	4.20	4.80	6.70	7.00	82
	Seat	4.20	5.00	8.70	10.70	83
	Back	2.60	2.80	3.40	3.50	51
	Arm	2.60	3.20	3.90	7.50	52
N84L2UA, N84L2UAO		13.30	14.70	19.70	23.20	266
N84L2UAX, N84L2UAOX	Upholstery	4.20	4.80	6.70	7.00	82
	Seat	4.20	5.00	8.70	10.70	83
	Back	2.60	2.80	3.40	3.50	51
	Arm	2.60	3.20	3.90	7.50	52
N84L2L, N84L2LO		12.00	13.40	18.40	21.20	241
N84L2LX, N84L2LOX	Upholstery	4.20	4.80	6.70	7.00	82
	Seat	4.20	5.00	8.70	10.70	83
	Back	2.60	2.80	3.40	3.50	51
	Arm	1.30	1.70	2.50	4.50	27
N84L2R, N84L2RO		12.00	13.40	18.40	21.20	241
N84L2RX, N84L2RX	Upholstery	4.20	4.80	6.70	7.00	82
	Seat	4.20	5.00	8.70	10.70	83
	Back	2.60	2.80	3.40	3.40	51
	Arm	1.30	1.70	2.50	4.50	27
N84L2M		10.70	12.00	16.10	18.70	214
N84L2MX	Upholstery	4.20	4.80	6.70	7.00	82
	Seat	4.20	5.00	8.80	10.70	83
	Back	2.60	2.80	3.40	3.40	51
N84L2UM		10.70	12.00	16.10	18.70	214
N84L2UMX	Upholstery	4.20	4.80	6.70	7.00	82
	Seat	4.20	5.00	8.80	10.70	83
	Back	2.60	2.80	3.40	3.40	51
N84L3A, N84L3AO		18.30	20.10	27.30	31.20	364

COM YARDAGE REQUIREMENTS

COM YARDAGE REQUIREMENTS (54" WIDTH – CUT UP THE ROLL)

MODEL	RAILROADED Contact customer service 800-482-1717 for ydg requirements	NON DIRECTIONAL OR SOLID	1"-4" REPEAT	5"-11" REPEAT	12"-18" REPEAT	COL SQUARE FEET
			4" VERTICAL X 4" HORIZONTAL	11" VERTICAL X 11" HORIZONTAL	18" VERTICAL X 18" HORIZONTAL	
N84L3AX, N84L3AOX	Upholstery	5.90	9.00	12.20	12.50	120
	Seat	6.30	7.00	12.90	15.70	124
	Back	3.90	4.20	4.80	5.00	73
	Arm	2.60	3.20	3.90	7.50	52
N84L3UA, N84L3UAO		18.30	20.10	27.30	31.20	364
N84L3UAX, N84L3UAOX	Upholstery	5.90	9.00	12.20	12.50	120
	Seat	6.30	7.00	12.90	15.70	124
	Back	3.90	4.20	4.80	5.00	73
	Arm	2.60	3.20	3.90	7.50	52
N84L3L, N84L3LO		17.00	18.90	25.90	29.10	338
N84L3LX, N84L3LOX	Upholstery	5.90	9.30	12.20	12.70	120
	Seat	6.30	9.00	12.20	12.50	128
	Back	3.90	4.20	4.80	5.00	73
	Arm	1.30	1.70	2.50	4.50	27
N84L3R, N84L3RO		17.00	18.90	25.90	29.10	338
N84L3RX, N84L3ROX	Upholstery	5.90	9.30	12.20	12.70	120
	Seat	6.30	9.00	12.20	12.50	128
	Back	3.90	4.20	4.80	5.00	73
	Arm	1.30	1.70	2.50	4.50	27
N84L3M		15.70	17.70	24.50	26.70	313
N84L3MX	Upholstery	5.90	9.30	12.20	12.70	120
	Seat	6.30	9.30	12.20	12.70	128
	Back	3.90	4.20	4.80	5.00	73
N84L3UM		15.70	17.70	24.50	26.70	313
N84L3UMX	Upholstery	5.90	9.30	12.20	12.70	120
	Seat	6.30	9.30	12.20	12.70	128
	Back	3.90	4.20	4.80	5.00	73
N84IN9L		8.00	8.70	11.50	11.70	160
N84IN9LX	Upholstery	3.70	4.00	5.60	5.90	80
	Seat	2.10	9.00	12.20	12.50	44
	Back	2.50	2.90	3.40	3.70	50
N84IN9R		8.00	8.70	11.50	11.70	160
N84IN9RX	Upholstery	3.70	4.00	5.60	5.90	80
	Seat	2.10	9.00	12.20	12.50	44
	Back	2.50	2.90	3.40	3.70	50
N84IN9D		8.40	9.60	12.90	15.20	173
N84IN9DX	Upholstery	3.70	4.70	6.70	7.00	83
	Seat	2.50	2.80	4.60	6.70	48
	Back	2.50	2.90	3.40	3.90	50
N84D1		3.30	3.80	7.00	9.10	67
N84D1X	Upholstery	1.20	1.80	3.20	4.70	26
	Seat	2.10	2.50	4.30	5.20	42
N84D1U		3.30	3.80	7.00	9.10	67
N84D1UX	Upholstery	1.20	1.80	3.20	4.70	26
	Seat	2.10	2.50	4.30	5.20	42
N84D2		3.50	4.00	7.00	10.10	70
N84D2X	Upholstery	1.20	1.80	3.20	4.70	26
	Seat	2.30	2.60	4.30	6.20	45
N84D2U		3.50	4.00	7.00	10.10	70
N84D2UX	Upholstery	1.20	1.80	3.20	4.70	26
	Seat	2.30	2.60	4.30	6.20	45
N84T36ENL		1.30	2.30	4.60	6.70	37
N84T36ENUL		1.30	2.30	4.60	6.70	37
N84T36ENS		1.30	2.30	4.60	6.70	37
N84T36ENUS		1.30	2.30	4.60	6.70	37
N84T60MGL		1.90	2.00	3.10	4.70	26
N84T60MGUL		1.90	2.00	3.10	4.70	26
N84T60MGS		1.90	2.00	3.40	4.70	26

COM YARDAGE REQUIREMENTS

COM YARDAGE REQUIREMENTS (54" WIDTH – CUT UP THE ROLL)

MODEL	RAILROADED Contact customer service 800-482-1717 for ydg requirements	NON DIRECTIONAL OR SOLID	1"-4" REPEAT	5"-11" REPEAT	12"-18" REPEAT	COL SQUARE FEET
			4" VERTICAL X 4" HORIZONTAL	11" VERTICAL X 11" HORIZONTAL	18" VERTICAL X 18" HORIZONTAL	
N84T60MGUS		1.90	2.00	3.40	4.70	26
N84CH1AO		10.1	11.20	13.80	15.60	201.45
N84CH1AOX	Upholstery	2.9	3.50	3.50	4.70	57.56
	Seat	3.6	4.00	5.90	8.10	70.84
	Back	1.3	1.50	2.10	2.30	26.57
	Arm	2.8	3.80	4.80	6.40	56.45
N84CH1LO		8.8	9.90	12.00	14.00	175.44
N84CH1LOX	Upholstery	2.9	3.50	3.50	4.70	57.56
	Seat	3.6	4.00	5.90	8.10	70.84
	Back	1.3	1.50	2.10	2.30	26.57
	Arm	1.6	2.40	3.00	3.40	30.99
N84CH1RO		8.8	9.90	12.00	14.00	175.44
N84CH1ROX	Upholstery	2.9	3.50	3.50	4.70	57.56
	Seat	3.6	4.00	5.90	8.10	70.84
	Back	1.3	1.50	2.10	2.30	26.57
	Arm	1.6	2.40	3.00	3.40	30.99
N84CH1M		7.5	8.40	10.70	13.00	149.98
N84CH1MX	Upholstery	2.9	3.50	3.50	4.70	57.56
	Seat	3.6	4.00	5.90	8.10	70.84
	Back	1.3	1.50	2.10	2.30	26.57

