RETURN TO WORK

Product Specifications	2
Product Options	3
Product Pages	7

RETURN TO WORK

PRODUCT SPECIFICATIONS

SCREENS

DESKS+WORKSTATIONS+BENCHING+TABLES

Accommodate new ways of working by utilizing your existing products and blending new solutions into workspaces

Create space division by adding a screen to your workspace. Select the screen style that best fits your situation: set on surface, edge mount, clamp mount, full metal edge mount, or freestanding

- Select style and height of screen based on floorplate layout and occupancy density. Taller screens are appropriate when employees must be situated face-to-face or are near high traffic areas
- Create additional shielding by adding set on surface screens to stations that already have existing edge mount screens
- Screens are available in a variety of materials. Be sure to specify bleach cleanable fabrics or hard surfaces such as acrylic
- Bulk pack pricing available – save money and reduce onsite packing materials by choosing this option. Contact our By Design Product Modifications Team for a price quote.

Keep in mind that it is essential to balance the need for privacy and protection with the overall feeling of the workplace environment.

Note: If you require screens that move with a height-adjustable worksurface, you will have to remove center screens. National recommends a 1" clearance on all sides to avoid pinch point hazards



Accessory Edge Mount Screens with Alloy Height Adjust + Epicenter Spine and Screens + Waveworks Pedestals



Accessory Edge Mount Screen + Alloy Height Adjustable Desk

DIMENSION KEY

D	Depth
W	Width
H	Height
A	Overhang: Approach Side
KW	Kneespace Width
DI	Diameter

SCREENS

SCREEN TYPE

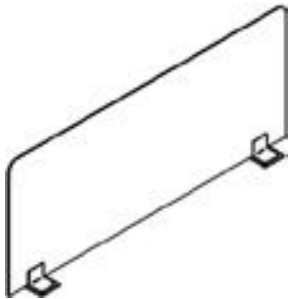

Set-On

Comes in Polycarbonate QD
 30"H, 24"W, 21-72"W
 Comes in 2 Resins Standard Lead Time
 Comes in PET Standard Lead Time
 30"H, 24"W, 18"H, 21-72"W
 1 person to install

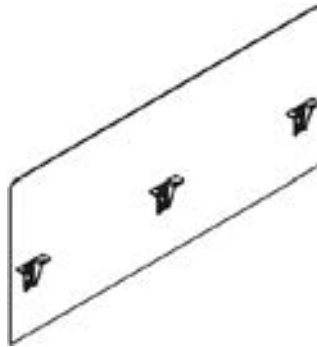

Edge Mount

Comes in Polycarbonate QD
 40/34"H, 30/24"H, 24/18"H, 21-72"W (privacy)
 44/30"H, 38/24"H, 32/18"H, 21-72"W
 (privacy/modesty)
 Comes in 2 Resins Standard Lead Time
 Comes in PET Standard Lead Time
 Comes in 3 Tack Board Fabric Patterns Standard
 Lead Time
 40/34"H, 30/24"H, 24/18"H, 21-72"W (privacy)
 44/30"H, 38/24"H, 32/18"H, 21-72"W
 (privacy/modesty)
 2 people to install

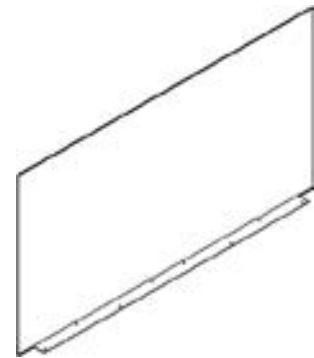

Full Metal Edge Mount

Comes in 2 Resins Standard Lead Time
 Comes in Glass Standard Lead Time
 24"H, 23-72"W
 2 people to install

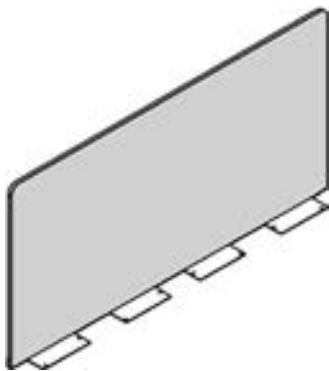

Full Edge Mount: PET

Comes in 1 PET Standard Lead Time
 24-30"H, 23-72"W
 2 people to install

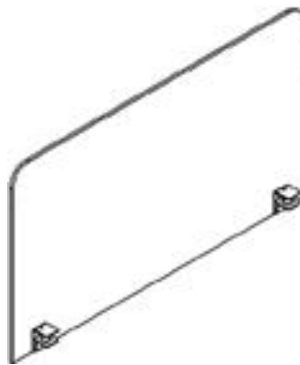

Clamp Mount

Comes in TFL White Laminate/Platinum Metallic
 paint brackets QD
 27H, 23-71W
 Comes in 2 Resins Standard Lead Time
 27"H, 23-71"W
 1 person to install

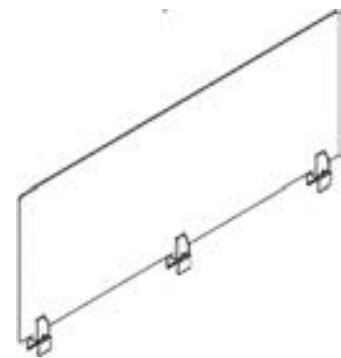

Universal Panel Mount

Comes in 2 Resins Standard Lead Time
 Comes in Glass Standard Lead Time
 18"H, 24-48"W
 2 people to install



Shaded model numbers are available on our
 "To You in 10 Days or Less" Quick Delivery
 program and will be delivered in 10 days or less.

RETURN TO WORK

SCREENS, *continued*

SCREEN TYPE

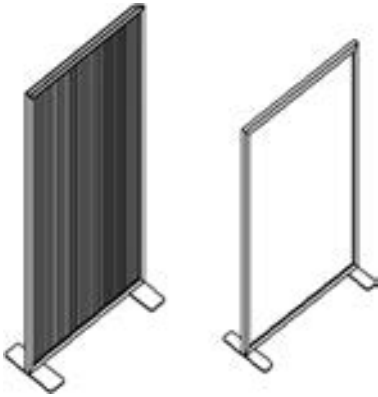

Static Floor Screen

Comes in Reeded Polycarbonate Standard Lead Time
Comes in Glass Standard Lead Time
Comes in HPL Laminate Standard Lead Time
Comes in HPL Marker Board Laminate Standard Lead Time
Comes in PET Standard Lead Time
Comes in 3 Tack Board Fabric Patterns Standard Lead Time
60"H or 72"H, 24-48"W
2 people to install

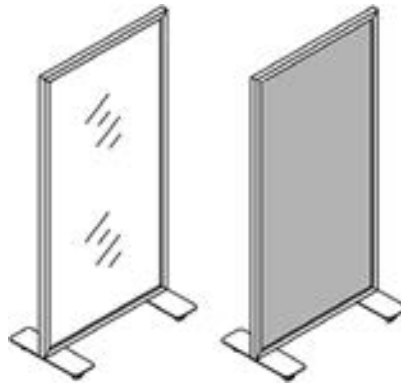

Mobile Floor Screen

Comes in Reeded Polycarbonate Standard Lead Time
Comes in Glass Standard Lead Time
Comes in HPL Laminate Standard Lead Time
Comes in HPL Marker Board Laminate Standard Lead Time
Comes in PET Standard Lead Time
Comes in 3 Tack Board Fabric Patterns Standard Lead Time
60"H or 72"H, 24-48"W
2 people to install

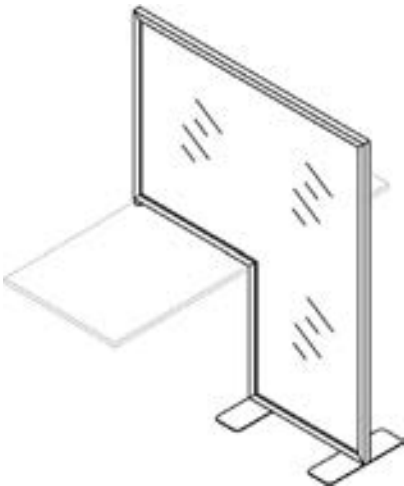

Static Surface/Floor Screen

Comes in Reeded Polycarbonate Standard Lead Time
Comes in Glass Standard Lead Time
Comes in HPL Laminate Standard Lead Time
Comes in HPL Marker Board Laminate Standard Lead Time
Comes in PET Standard Lead Time
Comes in 3 Tack Board Fabric Patterns Standard Lead Time
60"H or 72"H, 24-48"W
2 people to install

ACCESSORIES

EQUIPMENT RAIL



Wall Equipment Rail

Extruded Aluminum Rail with Silver Inlay
18¼"-48¼"W
2 people to install

ACCESSORIES FOR RAIL (1 PERSON INSTALL)

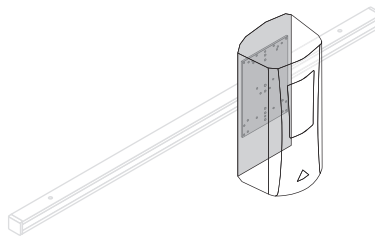

Mounting Kit for Wide-Body Soap/Sanitizer Dispenser

Designed to hold most wide-body soap or sanitizer dispensers

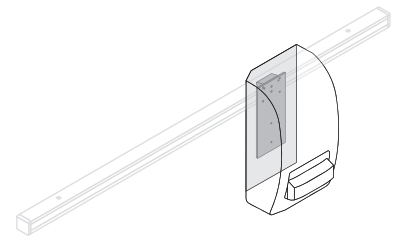

Mounting Kit for Narrow-Body Soap/Sanitizer Dispenser

Designed to hold most narrow-body soap or sanitizer dispensers

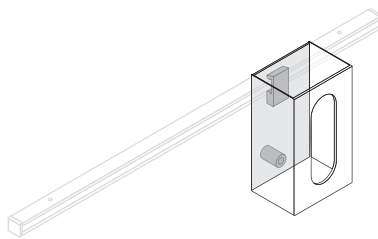

Single Universal Glove Box Holder

Clear Acrylic
Holds one glove box

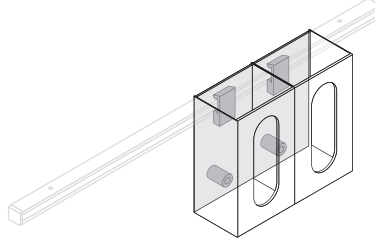

Double Universal Glove Box Holder

Clear Acrylic
Holds two glove boxes

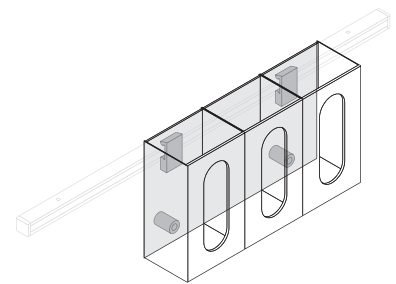

Triple Universal Glove Box Holder

Clear Acrylic
Holds three glove boxes

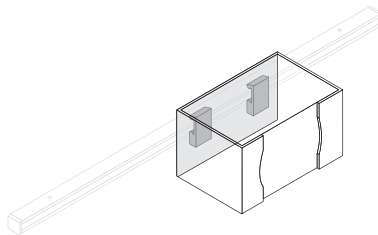

Small PPE Dispenser

ABS plastic
Universal small box dispenser for shoe cover, cap, and other items

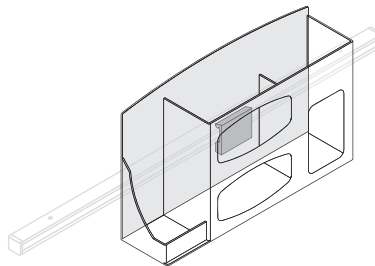

PPE Dispenser Cabinet

Holds 2 boxes of gloves, 1 box of face masks, and 1 hand sanitizer bottle

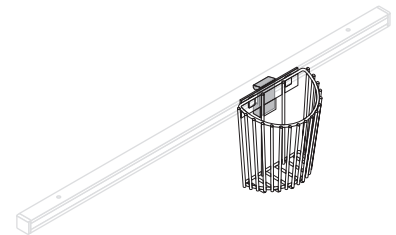

U-Shaped Wire Basket

Plastic coated wire
Holds blood pressure cuff and other accessories

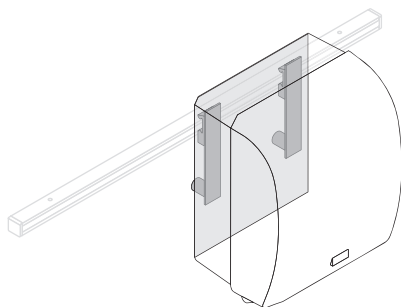

Mounting Kit for Paper Towel Dispenser

Designed to hold most paper towel dispensers

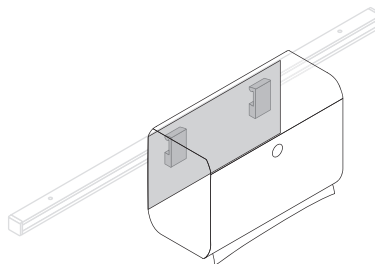

Mounting Kit for Tri-Fold Paper Towel Dispenser

Designed to hold most tri-fold dispensers

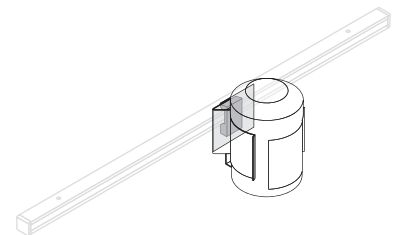

Wipe Holder

Designed to hold most brands of sanitizing wipes and some industrial style spray bottles

RETURN TO WORK

SCREEN PRODUCT OPTIONS

LAMINATE+BRACKET OPTIONS

CLAMP MOUNT TFL WOODGRAIN LAMINATE

IM Brighton
MC Amber
MH Mocha

CLAMP MOUNT TFL SOLID LAMINATE

405 Designer White
440 Cloud
461 Graphite
462 Cinder

POLYCARBONATE

Fluted, Semi-Opaque Polycarbonate

EDGE MOUNT AND SET-ON BRACKET PAINT COLORS

423 Concrete
462 Cinder
463 Iron
501 Platinum Metallic
503 Satin Nickel Metallic

CLAMP MOUNT AND FULL EDGE MOUNT BRACKET, AND FLOOR SCREEN FRAME PAINT COLORS

405 Designer White
462 Cinder
501 Platinum Metallic

RESIN COLORS

1677 Frosted
1377 Clear

EDGE MOUNT BRACKET APPLICATION

FL Flush
WG Wire Gap (+\$33 upcharge)

FLOOR SCREEN LAMINATE COLORS

AC2 Autumn 2	SM Sonoma
AD Almond	TF Truffle
BZ Brazilwood	WL Willow
CI Chai	405 Designer White
CL Caramel	419 Wallaby
CW Cordovan	425 Shadow
DW Judicial	440 Cloud
HN2 Honey 2	451 Dapple
IM Brighton	461 Graphite
KN Kona	462 Cinder
MC Amber	478 Platinum Grey
MH Mocha	488 Frosty White
NM Natural	491 Designer White Linear
PB Portobello	492 Cinder Linear
PC Porcini	792 Sable
PT Portico	793 Acorn
SK Skyline	

PET+TACKABLE UPHOLSTERY OPTIONS

PET FABRICS*

NOR Nordic Knit

DUNE (GRADE A) 100% POLYESTER*

8600 Drift
8601 Windblown
8602 Erosion
8603 Haze
8606 Pebble
8608 Nectar
8610 Clear
8614 Basin
8615 Raven
8620 Darkness

REPETITION (GRADE A) 100% PRE-CONSUMER RECYCLED POLYESTER*

3700 Ash
3703 White
3709 Java
3713 Stainless
3715 Almond
3721 Reed
3744 Tawny

PACT (GRADE B) 65% PRECONSUMER GRADE POLYESTER 35% POST-CONSUMER RECYCLED POLYESTER*

25401 Aloe	25412 Lime
25402 Azure	25413 Midnight
25403 Calla	25414 Nectar
25404 Coastal	25415 Patina
25405 Delft	25416 Putty
25406 Dove	25418 Roma
25409 Fern	25420 Sketch
25410 Harbour	25422 Taupe
25411 Lily	25423 Toasty

COM (GRADE B)*

*Available for Clamp Mount, Full Edge Mount, and Floor Screens

SET-ON SCREEN - DESKS+BENCHING



Shaded model numbers are available on our "To You in 10 Days or Less" Quick Delivery program and will be delivered in 10 days or less.

- Quick Delivery lead times applicable to orders of 20 screens or less

TO ORDER, SPECIFY:

1. Model Number

SAMPLE MODEL NUMBER:

NAC7230PVSBP

- See page 3 for Return To Work options

	MODEL NO./DESCRIPTION	LIST PRICE	DIMENSIONS			CARTONED CUBIC		
			D	W	H	A	KW	WEIGHT
POLYCARBONATE SET-ON SURFACE SCREEN 	¼" POLYCARBONATE THICKNESS 30" HIGH							
	NAC7230PVSBP	\$ 603		72	30			
	NAC6630PVSBP	592		66	30			
	NAC6030PVSBP	578		60	30			
	NAC5430PVSBP	568		54	30			
	NAC4830PVSBP	488		48	30			
	NAC4230PVSBP	485		42	30			
	NAC3630PVSBP	407		36	30			
	NAC3030PVSBP	366		30	30			
	NAC2730PVSBP	313		27	30			
	NAC2430PVSBP	305		24	30			
	NAC2130PVSBP	300		21	30			
	24" HIGH							
	NAC7224PVSBP	\$ 562		72	24			
	NAC6624PVSBP	554		66	24			
	NAC6024PVSBP	541		60	24			
	NAC5424PVSBP	531		54	24			
	NAC4824PVSBP	452		48	24			
	NAC4224PVSBP	451		42	24			
	NAC3624PVSBP	345		36	24			
	NAC3024PVSBP	320		30	24			
	NAC2724PVSBP	297		27	24			
	NAC2424PVSBP	291		24	24			
	NAC2124PVSBP	288		21	24			

- Quick Delivery Polycarbonate Set-On Screens feature Platinum Metallic brackets
- When ordering both back and side set-on screens, size down for side screens in order to avoid interference
- Clear rubber bumpers on bottom of brackets
- Clear U-Channel Edge Molding on all exposed edges
- Polycarbonate Thickness ¼"
- Foot dimension is 3" wide x 5" deep
- Semi-Opaque Reeded Polycarbonate
- Screen Metal Mounting Bracket
- Brackets ship in box with screen
- Remove protective film from screen
- Pressure fit screen into bracket and set in place
- Low level of complexity – can be installed by 1 person

SET-ON SCREEN - DESKS+BENCHING

TO ORDER, SPECIFY:

1. Model Number
2. Resin Color
3. Bracket Paint Color

SAMPLE MODEL NUMBER:

NAC7230PVSP

- See page 3 for Return To Work options

	MODEL NO./DESCRIPTION	LIST PRICE	DIMENSIONS			A	KW	CARTONED WEIGHT	CUBIC FEET
			D	W	H				
	¼" RESIN THICKNESS 30" HIGH								
	NAC7230PVSP	\$ 1576	72	30					
	NAC6630PVSP	1563	66	30					
	NAC6030PVSP	1547	60	30					
	NAC5430PVSP	1418	54	30					
	NAC4830PVSP	851	48	30					
	NAC4230PVSP	841	42	30					
	NAC3630PVSP	751	36	30					
	NAC3030PVSP	721	30	30					
	NAC2730PVSP	587	27	30					
	NAC2430PVSP	572	24	30					
	NAC2130PVSP	542	21	30					
		24" HIGH							
NAC7224PVSP	\$ 1124	72	24						
NAC6624PVSP	1111	66	24						
NAC6024PVSP	1097	60	24						
NAC5424PVSP	1053	54	24						
NAC4824PVSP	874	48	24						
NAC4224PVSP	695	42	24						
NAC3624PVSP	614	36	24						
NAC3024PVSP	598	30	24						
NAC2724PVSP	498	27	24						
NAC2424PVSP	488	24	24						
NAC2124PVSP	440	21	24						
	18" HIGH								
NAC7218PVSP	\$ 743	72	18						
NAC6618PVSP	727	66	18						
NAC6018PVSP	713	60	18						
NAC5418PVSP	670	54	18						
NAC4818PVSP	544	48	18						
NAC4218PVSP	538	42	18						
NAC3618PVSP	467	36	18						
NAC3018PVSP	440	30	18						
NAC2718PVSP	407	27	18						
NAC2418PVSP	397	24	18						
NAC2118PVSP	380	21	18						

- When ordering both back and side set-on screens, size down for side screens in order to avoid interference
- Clear rubber bumpers on bottom of brackets
- Bulk pack pricing available – save money and reduce onsite packing materials by choosing this option. Contact our By Design Product Modifications Team for a price quote
- Resin Thickness ¼"
- Foot dimension is 3" wide x 5" deep
- Clear or Frosted Resin Screen
- Metal Mounting Bracket
- Brackets ship in box with screen
- Remove protective film from screen
- Pressure fit screen into bracket and set in place
- Medium complexity – 4 minutes, 2 people

SET-ON SCREEN - DESKS+BENCHING

TO ORDER, SPECIFY:

1. Model Number
2. Bracket Paint Color

SAMPLE MODEL NUMBER:

NAC7230PVSPP

- See page 3 for Return To Work options

	MODEL NO./DESCRIPTION	LIST PRICE	DIMENSIONS			A	KW	CARTONED WEIGHT	CUBIC FEET
			D	W	H				
PET SET-ON SURFACE SCREEN	½" PET THICKNESS 30" HIGH								
	NAC7230PVSPP	\$ 1448		72	30				
	NAC6630PVSPP	1396		66	30				
	NAC6030PVSPP	1365		60	30				
	NAC5430PVSPP	1139		54	30				
	NAC4830PVSPP	751		48	30				
	NAC4230PVSPP	721		42	30				
	NAC3630PVSPP	660		36	30				
	NAC3030PVSPP	614		30	30				
	NAC2730PVSPP	549		27	30				
	NAC2430PVSPP	382		24	30				
	NAC2130PVSPP	381		21	30				
	24" HIGH								
	NAC7224PVSPP	\$ 802		72	24				
	NAC6624PVSPP	761		66	24				
	NAC6024PVSPP	751		60	24				
	NAC5424PVSPP	667		54	24				
	NAC4824PVSPP	604		48	24				
	NAC4224PVSPP	544		42	24				
	NAC3624PVSPP	457		36	24				
	NAC3024PVSPP	423		30	24				
	NAC2724PVSPP	339		27	24				
	NAC2424PVSPP	312		24	24				
	NAC2124PVSPP	275		21	24				
	18" HIGH								
	NAC7218PVSPP	\$ 788		72	18				
	NAC6618PVSPP	758		66	18				
	NAC6018PVSPP	739		60	18				
	NAC5418PVSPP	658		54	18				
	NAC4818PVSPP	583		48	18				
	NAC4218PVSPP	527		42	18				
	NAC3618PVSPP	443		36	18				
	NAC3018PVSPP	409		30	18				
	NAC2718PVSPP	297		27	18				
	NAC2418PVSPP	246		24	18				
	NAC2118PVSPP	245		21	18				

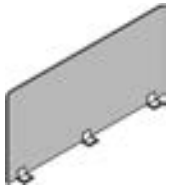

- When ordering both back and side set-on screens, size down for side screens in order to avoid interference
- Clear rubber bumpers on bottom of brackets
- PET Thickness ½"
- Foot dimension is 3" wide x 5" deep
- Nordic Knit PET Screen
- Metal Mounting Bracket
- Brackets ship in box with screen
- Remove protective film from screen
- Pressure fit screen into bracket and set in place
- Medium complexity – 4 minutes, 2 people

CLAMP MOUNT SCREEN - DESKS+BENCHING



Shaded model numbers are available on our "To You in 10 Days or Less" Quick Delivery program and will be delivered in 10 days or less.

- Quick Delivery lead times applicable to orders of 20 screens or less

TO ORDER, SPECIFY:

1. Model Number
2. Laminate Color
3. Clamp Paint Color

SAMPLE MODEL NUMBERS:

QNAC7127PVC2405501
NAC7127PVCC2LLP

- See page 3 for Return To Work options

	MODEL NO./DESCRIPTION	LIST PRICE	DIMENSIONS			A	KW	CARTONED WEIGHT	CUBIC FEET
			D	W	H				
TFL CLAMP MOUNT SCREEN 	½" TFL THICKNESS								
	QNAC7127PVC2405501	\$ 789	71		27				
	QNAC6527PVC2405501	775	65		27				
	QNAC5927PVC2405501	735	59		27				
	QNAC5327PVC2405501	629	53		27				
	QNAC4727PVC2405501	605	47		27				
	QNAC2927PVC2405501	534	29		27				
	QNAC2327PVC2405501	509	23		27				

- Quick Delivery models feature Designer White Laminate and Platinum Metallic Clamps

½" TFL THICKNESS

NAC7127PVCC2LLP	\$ 789	71		27					
NAC6527PVCC2LLP	775	65		27					
NAC5927PVCC2LLP	735	59		27					
NAC5327PVCC2LLP	629	53		27					
NAC4727PVCC2LLP	605	47		27					
NAC2927PVCC2LLP	534	29		27					
NAC2327PVCC2LLP	509	23		27					

- Bulk pack pricing available – save money and reduce onsite packing materials by choosing this option. Contact our By Design Product Modifications Team for a price quote

- Above worksurface height is 24"
- Extends 3" below the worksurface
- Fits on ¾" – 1½" worksurface thicknesses
- Grain direction is always Horizontal
- Size down to avoid pinch points on height adjust worksurfaces, as well as when both front and side screens are specified
- Clamp is plastic with a non-marring foam
- TFL Thickness ½"
- Above surface height is 24"
- TFL Panel
- Metal Clamp
- Brackets ship attached to screen
- Tighten thumb screw to secure to surface
- Low level of complexity – can be installed by 1 person

CLAMP MOUNT SCREEN - DESKS+BENCHING

TO ORDER, SPECIFY:

1. Model Number
2. Laminate Color
3. Clamp Paint Color

SAMPLE MODEL NUMBER:

NAC7127PVCC2P

- See page 3 for Return To Work options

RESIN CLAMP MOUNT SCREEN	MODEL NO./DESCRIPTION	LIST PRICE	DIMENSIONS				CARTONED WEIGHT	CUBIC FEET
			D	W	H	A		
	¼" RESIN THICKNESS							
	NAC7127PVCC2P	\$ 1327		71	27			
	NAC6527PVCC2P	1306		65	27			
	NAC5927PVCC2P	1289		59	27			
	NAC5327PVCC2P	952		53	27			
	NAC4727PVCC2P	853		47	27			
	NAC2927PVCC2P	756		29	27			
	NAC2327PVCC2P	585		23	27			

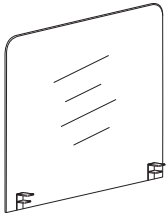

- Size down to avoid pinch points on height adjust worksurfaces, as well as when both front and side screens are specified
- Fits on ¼" - 1½" worksurface thicknesses
- Screen extends 24" above worksurface
- Extends 3" Below Worksurface
- Clamp is plastic with a non-marring foam
- Bulk pack pricing available – save money and reduce onsite packing materials by choosing this option. Contact our By Design Product Modifications Team for a price quote
- Resin Thickness ¼"
- Clear or Frosted Resin Screen
- Metal Clamp
- Brackets ship attached to screen
- Tighten thumb screw to secure to surface
- Easy to install - can be installed by 1 person

EDGE MOUNT SCREEN - DESKS+BENCHING



Shaded model numbers are available on our "To You in 10 Days or Less" Quick Delivery program and will be delivered in 10 days or less.

- Quick Delivery lead times applicable to orders of 20 screens or less

TO ORDER, SPECIFY:

1. Model Number

SAMPLE MODEL NUMBER:

NAC7240PVCBP

- See page 3 for Return To Work options

POLYCARBONATE EDGE MOUNT SURFACE SCREEN	MODEL NO./DESCRIPTION	LIST PRICE	DIMENSIONS			CARTONED CUBIC WEIGHT FEET
			D	W	H	
	¼" POLYCARBONATE THICKNESS 40" HIGH					ABOVE WORKSURFACE H
	NAC7240PVCBP	\$ 459	72	40	34	
	NAC6640PVCBP	450	66	40	34	
	NAC6040PVCBP	439	60	40	34	
	NAC5440PVCBP	431	54	40	34	
	NAC4840PVCBP	420	48	40	34	
	NAC4240PVCBP	411	42	40	34	
	NAC3640PVCBP	382	36	40	34	
	NAC3040PVCBP	285	30	40	34	
	NAC2740PVCBP	258	27	40	34	
	NAC2440PVCBP	246	24	40	34	
	NAC2140PVCBP	240	21	40	34	
	30" HIGH					
NAC7230PVCBP	\$ 390	72	30	24		
NAC6630PVCBP	384	66	30	24		
NAC6030PVCBP	376	60	30	24		
NAC5430PVCBP	368	54	30	24		
NAC4830PVCBP	360	48	30	24		
NAC4230PVCBP	353	42	30	24		
NAC3630PVCBP	\$ 324	36	30	24		
NAC3030PVCBP	251	30	30	24		
NAC2730PVCBP	247	27	30	24		
NAC2430PVCBP	222	24	30	24		
NAC2130PVCBP	217	21	30	24		
	24" HIGH					
NAC7224PVCBP	\$ 351	72	24	18		
NAC6624PVCBP	345	66	24	18		
NAC6024PVCBP	337	60	24	18		
NAC5424PVCBP	332	54	24	18		
NAC4824PVCBP	323	48	24	18		
NAC4224PVCBP	317	42	24	18		
NAC3624PVCBP	239	36	24	18		
NAC3024PVCBP	231	30	24	18		
NAC2724PVCBP	228	27	24	18		
NAC2424PVCBP	209	24	24	18		
NAC2124PVCBP	202	21	24	18		

- Quick Delivery Screens will feature Platinum Metallic mounting brackets. Specify bracket application
- Screen extends 4" below worksurface
- Clear U-Channel edge molding attached on all sides of screen
- Fits on 1½" - 1¾" worksurface thicknesses
- Polycarbonate Thickness ¼"
- Semi-Opaque Reeded Polycarbonate Screen
- Metal Mounting Bracket
- When ordering both back and side edge mount screens, size down for side screens to avoid interference
- Brackets ship in box with screen
- Remove protective film from screen
- Edge Mount Privacy Panel faceplate can be installed horizontally or vertically
- Will require attachment to surface with fasteners - 2 people recommended for installation

EDGE MOUNT SCREEN - DESKS+BENCHING

TO ORDER, SPECIFY:

1. Model Number
2. Bracket Application
3. Resin Color
4. Bracket Paint Color

SAMPLE MODEL NUMBER:

NAC7240PVCP

- See page 3 for Return To Work options

**RESIN EDGE MOUNT
SURFACE SCREEN**



MODEL NO./DESCRIPTION	LIST PRICE	DIMENSIONS			CARTONED WEIGHT	CUBIC FEET
		D	W	H		
¼" RESIN THICKNESS 40" HIGH						
ABOVE WORKSURFACE H						
NAC7240PVCP	\$ 1150	72	40	34		
NAC6640PVCP	1137	66	40	34		
NAC6040PVCP	991	60	40	34		
NAC5440PVCP	979	54	40	34		
NAC4840PVCP	943	48	40	34		
NAC4240PVCP	933	42	40	34		
NAC3640PVCP	652	36	40	34		
NAC3040PVCP	573	30	40	34		
NAC2740PVCP	566	27	40	34		
NAC2440PVCP	492	24	40	34		
NAC2140PVCP	485	21	40	34		
30" HIGH						
NAC7230PVCP	\$ 894	72	30	24		
NAC6630PVCP	889	66	30	24		
NAC6030PVCP	780	60	30	24		
NAC5430PVCP	772	54	30	24		
NAC4830PVCP	690	48	30	24		
NAC4230PVCP	682	42	30	24		
NAC3630PVCP	522	36	30	24		
NAC3030PVCP	488	30	30	24		
NAC2730PVCP	483	27	30	24		
NAC2430PVCP	404	24	30	24		
NAC2130PVCP	399	21	30	24		
24" HIGH						
NAC7224PVCP	\$ 604	72	24	18		
NAC6624PVCP	601	66	24	18		
NAC6024PVCP	440	60	24	18		
NAC5424PVCP	431	54	24	18		
NAC4824PVCP	378	48	24	18		
NAC4224PVCP	401	42	24	18		
NAC3624PVCP	308	36	24	18		
NAC3024PVCP	290	30	24	18		
NAC2724PVCP	286	27	24	18		
NAC2424PVCP	261	24	24	18		
NAC2124PVCP	258	21	24	18		

- Screen extends 4" below worksurface
- Resin available in Clear or Frosted with radiused corners
- Fits on 1³/₈" - 1⁷/₈" worksurface thicknesses
- Bulk pack pricing available - save money and reduce onsite packing materials by choosing this option. Contact our By Design Product Modifications Team for a price quote
- Resin Thickness ¼"
- Clear or Frosted Resin Screen
- Metal Mounting Bracket
- When ordering both back and side edge mount screens, size down for side screens to avoid interface
- Brackets ship in box with screen
- Remove protective film from screen
- Edge Mount Privacy Panel faceplate can be installed horizontally or vertically
- Will require attachment to surface with fasteners - 2 people recommended for installation

EDGE MOUNT SCREEN - DESKS+BENCHING

TO ORDER, SPECIFY:

1. Model Number
2. Bracket Application
3. Bracket Paint Color

SAMPLE MODEL NUMBER:

NAC7240PVCPP

- See page 3 for Return To Work options

MODEL NO./DESCRIPTION	LIST PRICE	DIMENSIONS			CARTONED WEIGHT	CUBIC FEET
		D	W	H		
PET EDGE MOUNT SCREEN						
½" PET THICKNESS 40" HIGH						ABOVE WORKSURFACE H
NAC7240PVCPP	\$ 1463	72	40	34		
NAC6640PVCPP	1403	66	40	34		
NAC6040PVCPP	1375	60	40	34		
NAC5440PVCPP	1156	54	40	34		
NAC4840PVCPP	1045	48	40	34		
NAC4240PVCPP	955	42	40	34		
NAC3640PVCPP	946	36	40	34		
NAC3040PVCPP	713	30	40	34		
NAC2740PVCPP	576	27	40	34		
NAC2440PVCPP	515	24	40	34		
NAC2140PVCPP	445	21	40	34		
30" HIGH						
NAC7230PVCPP	\$ 1447	72	30	24		
NAC6630PVCPP	1389	66	30	24		
NAC6030PVCPP	1363	60	30	24		
NAC5430PVCPP	1139	54	30	24		
NAC4830PVCPP	877	48	30	24		
NAC4230PVCPP	749	42	30	24		
NAC3630PVCPP	713	36	30	24		
NAC3030PVCPP	689	30	30	24		
NAC2730PVCPP	490	27	30	24		
NAC2430PVCPP	377	24	30	24		
NAC2130PVCPP	375	21	30	24		
24" HIGH						
NAC7224PVCPP	\$ 795	72	24	18		
NAC6624PVCPP	766	66	24	18		
NAC6024PVCPP	745	60	24	18		
NAC5424PVCPP	658	54	24	18		
NAC4824PVCPP	596	48	24	18		
NAC4224PVCPP	536	42	24	18		
NAC3624PVCPP	449	36	24	18		
NAC3024PVCPP	414	30	24	18		
NAC2724PVCPP	357	27	24	18		
NAC2424PVCPP	339	24	24	18		
NAC2124PVCPP	312	21	24	18		



- Screen extends 4" below worksurface
- PET Screen with radiused corners
- Fits on 1½" - 1¾" worksurface thicknesses
- PET Thickness ½"
- Nordic Knit PET Screen
- Metal Mounting Bracket
- When ordering both back and side edge mount screens, size down for side screens to avoid interface
- Brackets ship in box with screen
- Remove protective film from screen
- Edge Mount Privacy Panel faceplate can be installed horizontally or vertically
- Will require attachment to surface with fasteners - 2 people recommended for installation

EDGE MOUNT SCREEN - DESKS+BENCHING

TO ORDER, SPECIFY:

1. Model Number
2. Bracket Application
3. Fabric Grade / Color
4. Bracket Paint Color

SAMPLE MODEL NUMBER:

NAC7240PVC2PFA

- See page 3 for Return To Work options

TACK BOARD FABRIC EDGE MOUNT SCREEN



MODEL NO./DESCRIPTION	LIST PRICE	DIMENSIONS			CARTONED WEIGHT	CUBIC FEET
		D	W	H		
1" FABRIC SCREEN THICKNESS 40" HIGH	GRADE A	GRADE B/ COM	ABOVE WORKSURFACE H			
NAC7240PVC2PFA	\$ 1534	\$ 1704	72	40	34	
NAC6640PVC2PFA	1450	1606	66	40	34	
NAC6040PVC2PFA	1350	1494	60	40	34	
NAC5440PVC2PFA	1256	1386	54	40	34	
NAC4840PVC2PFA	1157	1273	48	40	34	
NAC4240PVC2PFA	1087	1191	42	40	34	
NAC3640PVC2PFA	997	1087	36	40	34	
NAC3040PVC2PFA	903	979	30	40	34	
NAC2740PVC2PFA	856	926	27	40	34	
NAC2440PVC2PFA	780	844	24	40	34	
NAC2140PVC2PFA	745	801	21	40	34	
30" HIGH						
NAC7230PVC2PFA	\$ 1312	\$ 1482	72	30	24	
NAC6630PVC2PFA	1232	1388	66	30	24	
NAC6030PVC2PFA	1153	1297	60	30	24	
NAC5430PVC2PFA	1071	1201	54	30	24	
NAC4830PVC2PFA	991	1107	48	30	24	
NAC4230PVC2PFA	912	1016	42	30	24	
NAC3630PVC2PFA	830	920	36	30	24	
NAC3030PVC2PFA	752	828	30	30	24	
NAC2730PVC2PFA	708	778	27	30	24	
NAC2430PVC2PFA	611	675	24	30	24	
NAC2130PVC2PFA	582	638	21	30	24	
24" HIGH						
NAC7224PVC2PFA	\$ 1044	\$ 1134	72	24	18	
NAC6624PVC2PFA	990	1070	66	24	18	
NAC6024PVC2PFA	936	1016	60	24	18	
NAC5424PVC2PFA	875	945	54	24	18	
NAC4824PVC2PFA	818	878	48	24	18	
NAC4224PVC2PFA	766	826	42	24	18	
NAC3624PVC2PFA	687	737	36	24	18	
NAC3024PVC2PFA	634	674	30	24	18	
NAC2724PVC2PFA	603	643	27	24	18	
NAC2424PVC2PFA	569	609	24	24	18	
NAC2124PVC2PFA	536	566	21	24	18	

- Screen extends 4" below worksurface
- PET Screen with radiused corners
- Fits on 1 1/8" - 1 3/8" worksurface thicknesses
- Fabric Screen Thickness 1"
- Dune , Repetition (grade A), or Pact (grade B) tack board fabrics
- Metal Mounting Bracket
- When ordering both back and side edge mount screens, size down for side screens to avoid interface
- Brackets ship in box with screen
- Remove protective film from screen
- Edge Mount Privacy Panel faceplate can be installed horizontally or vertically
- Will require attachment to surface with fasteners - 2 people recommended for installation

EDGE MOUNT SCREEN/MODESTY - DESKS+BENCHING



Shaded model numbers are available on our "To You in 10 Days or Less" Quick Delivery program and will be delivered in 10 days or less.

- Quick Delivery lead times applicable to orders of 20 screens or less

TO ORDER, SPECIFY:

1. Model Number

SAMPLE MODEL NUMBER:

NAC7244PVMCBP

- See page 3 for Return To Work options

POLYCARBONATE EDGE MOUNT SURFACE SCREEN/MODESTY	MODEL NO./DESCRIPTION	LIST PRICE	DIMENSIONS			CARTONED CUBIC	
			D	W	H	A	KW
	¼" POLYCARBONATE THICKNESS 44" HIGH						ABOVE WORKSURFACE H
	NAC7244PVMCBP	\$ 1072	72	44	30		
	NAC6644PVMCBP	1070	66	44	30		
	NAC6044PVMCBP	744	60	44	30		
	NAC5444PVMCBP	743	54	44	30		
	NAC4844PVMCBP	645	48	44	30		
	NAC4244PVMCBP	641	42	44	30		
	NAC3644PVMCBP	621	36	44	30		
	NAC3044PVMCBP	463	30	44	30		
	NAC2744PVMCBP	461	27	44	30		
	NAC2444PVMCBP	413	24	44	30		
	NAC2144PVMCBP	411	21	44	30		
	38" HIGH						
NAC7238PVMCBP	\$ 1065	72	38	24			
NAC6638PVMCBP	1063	66	38	24			
NAC6038PVMCBP	735	60	38	24			
NAC5438PVMCBP	734	54	38	24			
NAC4838PVMCBP	637	48	38	24			
NAC4238PVMCBP	634	42	38	24			
NAC3638PVMCBP	614	36	38	24			
NAC3038PVMCBP	458	30	38	24			
NAC2738PVMCBP	454	27	38	24			
NAC2438PVMCBP	407	24	38	24			
NAC2138PVMCBP	406	21	38	24			
	32" HIGH						
NAC7232PVMCBP	\$ 438	72	32	18			
NAC6632PVMCBP	436	66	32	18			
NAC6032PVMCBP	414	60	32	18			
NAC5432PVMCBP	413	54	32	18			
NAC4832PVMCBP	409	48	32	18			
NAC4232PVMCBP	406	42	32	18			
NAC3632PVMCBP	299	36	32	18			
NAC3032PVMCBP	293	30	32	18			
NAC2732PVMCBP	291	27	32	18			
NAC2432PVMCBP	261	24	32	18			
NAC2132PVMCBP	260	21	32	18			

- Quick Delivery Screens will feature Platinum Metallic mounting brackets. Specify bracket application
- Screen extends 12" below worksurface
- Clear U-Channel edge molding attached on all sides of screen
- Fits on 1½" - 1¾" worksurface thicknesses
- Polycarbonate Thickness ¼"
- Semi-Opaque Reeded Polycarbonate Screen
- Metal Mounting Bracket
- When ordering both back and side edge mount screens, size down for side screens to avoid interference
- Brackets ship in box with screen
- Remove protective film from screen
- Edge Mount Privacy Panel faceplate can be installed horizontally or vertically
- Will require attachment to surface with fasteners - 2 people recommended for installation

EDGE MOUNT SCREEN/MODESTY - DESKS+BENCHING

TO ORDER, SPECIFY:

1. Model Number
2. Bracket Application
3. Resin Color
4. Bracket Paint Color

SAMPLE MODEL NUMBER:

NAC7244PVMCP

- See page 3 for Return To Work options

RESIN EDGE MOUNT SURFACE SCREEN/MODESTY	MODEL NO./DESCRIPTION	LIST PRICE	DIMENSIONS			A	KW	CARTONED WEIGHT	CUBIC FEET
			D	W	H				
	¼" RESIN THICKNESS 44" HIGH								ABOVE WORKSURFACE H
	NAC7244PVMCP	\$ 1515		72	44	30			
	NAC6644PVMCP	1510		66	44	30			
	NAC6044PVMCP	1280		60	44	30			
	NAC5444PVMCP	1278		54	44	30			
	NAC4844PVMCP	910		48	44	30			
	NAC4244PVMCP	904		42	44	30			
	NAC3644PVMCP	838		36	44	30			
	NAC3044PVMCP	659		30	44	30			
	NAC2744PVMCP	656		27	44	30			
NAC2444PVMCP	544		24	44	30				
NAC2144PVMCP	541		21	44	30				
	38" HIGH								
	NAC7238PVMCP	\$ 1087		72	38	24			
	NAC6638PVMCP	1082		66	38	24			
	NAC6038PVMCP	923		60	38	24			
	NAC5438PVMCP	921		54	38	24			
	NAC4838PVMCP	894		48	38	24			
	NAC4238PVMCP	889		42	38	24			
	NAC3638PVMCP	621		36	38	24			
	NAC3038PVMCP	549		30	38	24			
	NAC2738PVMCP	545		27	38	24			
	NAC2438PVMCP	475		24	38	24			
	NAC2138PVMCP	474		21	38	24			
	32" HIGH								
	NAC7232PVMCP	\$ 1060		72	32	18			
	NAC6632PVMCP	1057		66	32	18			
	NAC6032PVMCP	722		60	32	18			
	NAC5432PVMCP	718		54	32	18			
	NAC4832PVMCP	691		48	32	18			
	NAC4232PVMCP	630		42	32	18			
	NAC3632PVMCP	603		36	32	18			
	NAC3032PVMCP	457		30	32	18			
	NAC2732PVMCP	442		27	32	18			
	NAC2432PVMCP	411		24	32	18			
	NAC2132PVMCP	399		21	32	18			

- Screen extends 12" below worksurface
- Resin available in Clear or Frosted with radiused corners
- Fits on 1³/₈" - 1⁷/₈" worksurface thicknesses
- Bulk pack pricing available - save money and reduce onsite packing materials by choosing this option. Contact our By Design Product Modifications Team for a price quote
- Resin Thickness ¼"
- Clear or Frosted Resin Screen
- Metal Mounting Bracket
- When ordering both back and side edge mount screens, size down for side screens to avoid interface
- Brackets ship in box with screen
- Remove protective film from screen
- Edge Mount Privacy Panel faceplate can be installed horizontally or vertically
- Will require attachment to surface with fasteners - 2 people recommended for installation

EDGE MOUNT SCREEN/MODESTY - DESKS+BENCHING

TO ORDER, SPECIFY:

1. Model Number
2. Bracket Application
3. Bracket Paint Color

SAMPLE MODEL NUMBER:

NAC7244PVMCPP

- See page 3 for Return To Work options

MODEL NO./DESCRIPTION	LIST PRICE	DIMENSIONS			CARTONED CUBIC			
		D	W	H	A	KW	WEIGHT	FEET
PET EDGE MOUNT SURFACE SCREEN/MODESTY SCREEN								
½" PET THICKNESS 44" HIGH					ABOVE WORKSURFACE H			
NAC7244PVMCPP	\$ 1463	72	44	30				
NAC6644PVMCPP	1408	66	44	30				
NAC6044PVMCPP	1386	60	44	30				
NAC5444PVMCPP	1168	54	44	30				
NAC4844PVMCPP	1051	48	44	30				
NAC4244PVMCPP	968	42	44	30				
NAC3644PVMCPP	959	36	44	30				
NAC3044PVMCPP	716	30	44	30				
NAC2744PVMCPP	588	27	44	30				
NAC2444PVMCPP	520	24	44	30				
NAC2144PVMCPP	454	21	44	30				
38" HIGH								
NAC7238PVMCPP	\$ 1458	72	38	24				
NAC6638PVMCPP	1401	66	38	24				
NAC6038PVMCPP	1373	60	38	24				
NAC5438PVMCPP	1152	54	38	24				
NAC4838PVMCPP	1042	48	38	24				
NAC4238PVMCPP	946	42	38	24				
NAC3638PVMCPP	932	36	38	24				
NAC3038PVMCPP	704	30	38	24				
NAC2738PVMCPP	555	27	38	24				
NAC2438PVMCPP	508	24	38	24				
NAC2138PVMCPP	438	21	38	24				
32" HIGH								
NAC7232PVMCPP	\$ 1452	72	32	18				
NAC6632PVMCPP	1393	66	32	18				
NAC6032PVMCPP	1370	60	32	18				
NAC5432PVMCPP	1144	54	32	18				
NAC4832PVMCPP	897	48	32	18				
NAC4232PVMCPP	768	42	32	18				
NAC3632PVMCPP	726	36	32	18				
NAC3032PVMCPP	699	30	32	18				
NAC2732PVMCPP	499	27	32	18				
NAC2432PVMCPP	383	24	32	18				
NAC2132PVMCPP	382	21	32	18				

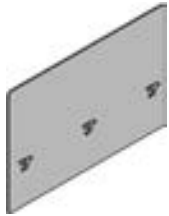

- Screen extends 12" below worksurface
- PET Screen with radiused corners
- Fits on 1 1/8" - 1 1/16" worksurface thicknesses
- PET Thickness ½"
- Nordic Knit PET Screen
- Metal Mounting Bracket
- When ordering both back and side edge mount screens, size down for side screens to avoid interface
- Brackets ship in box with screen
- Remove protective film from screen
- Edge Mount Privacy Panel faceplate can be installed horizontally or vertically
- Will require attachment to surface with fasteners - 2 people recommended for installation

EDGE MOUNT SCREEN/MODESTY - DESKS+BENCHING

TO ORDER, SPECIFY:

1. Model Number
2. Bracket Application
3. Fabric Grade / Color
4. Bracket Paint Color

SAMPLE MODEL NUMBER:

NAC7244PVMC2PFA

- See page 3 for Return To Work options

**TACK BOARD FABRIC
EDGE MOUNT SURFACE
SCREEN/MODESTY SCREEN**

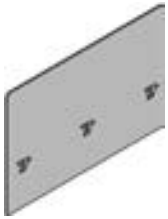

MODEL NO./DESCRIPTION	LIST PRICE	DIMENSIONS			CARTONED WEIGHT	CUBIC FEET
		D	W	H		
1" FABRIC SCREEN THICKNESS 44" HIGH						
NAC7244PVMC2PFA	\$ 1454	\$ 1624	72	44	30	
NAC6644PVMC2PFA	1369	1525	66	44	30	
NAC6044PVMC2PFA	1268	1412	60	44	30	
NAC5444PVMC2PFA	1181	1311	54	44	30	
NAC4844PVMC2PFA	1093	1209	48	44	30	
NAC4244PVMC2PFA	1012	1116	42	44	30	
NAC3644PVMC2PFA	922	1012	36	44	30	
NAC3044PVMC2PFA	837	913	30	44	30	
NAC2744PVMC2PFA	788	858	27	44	30	
NAC2444PVMC2PFA	725	789	24	44	30	
NAC2144PVMC2PFA	693	749	21	44	30	
38" HIGH						
NAC7238PVMC2PFA	\$ 1400	\$ 1570	72	38	24	
NAC6638PVMC2PFA	1312	1468	66	38	24	
NAC6038PVMC2PFA	1213	1357	60	38	24	
NAC5438PVMC2PFA	1133	1263	54	38	24	
NAC4838PVMC2PFA	1045	1161	48	38	24	
NAC4238PVMC2PFA	966	1070	42	38	24	
NAC3638PVMC2PFA	884	974	36	38	24	
NAC3038PVMC2PFA	797	873	30	38	24	
NAC2738PVMC2PFA	754	824	27	38	24	
NAC2438PVMC2PFA	676	740	24	38	24	
NAC2138PVMC2PFA	645	701	21	38	24	
32" HIGH						
NAC7232PVMC2PFA	\$ 1463	\$ 1633	72	32	18	
NAC6632PVMC2PFA	1374	1534	66	32	18	
NAC6032PVMC2PFA	1274	1418	60	32	18	
NAC5432PVMC2PFA	1189	1319	54	32	18	
NAC4832PVMC2PFA	1097	1217	48	32	18	
NAC4232PVMC2PFA	1013	1117	42	32	18	
NAC3632PVMC2PFA	906	996	36	32	18	
NAC3032PVMC2PFA	822	902	30	32	18	
NAC2732PVMC2PFA	776	846	27	32	18	
NAC2432PVMC2PFA	685	755	24	32	18	
NAC2132PVMC2PFA	654	714	21	32	18	

- Screen extends 12" below worksurface
- Tack board fabric Screen with radiused corners
- Fits on 1 1/8" - 1 3/8" worksurface thicknesses
- Fabric Screen Thickness 1"
- Dune , Repetition (grade A), or Pact (grade B) tack board fabrics
- Metal Mounting Bracket
- When ordering both back and side edge mount screens, size down for side screens to avoid interface
- Brackets ship in box with screen
- Remove protective film from screen
- Edge Mount Privacy Panel faceplate can be installed horizontally or vertically
- Will require attachment to surface with fasteners - 2 people recommended for installation

FULL EDGE MOUNT SCREEN - DESKS+BENCHING

TO ORDER, SPECIFY:

1. Model Number
2. Bracket Paint Color

SAMPLE MODEL NUMBER:

- NAC7224PVEGP
 • See page 3 for Return To Work options

MODEL NO./DESCRIPTION	LIST PRICE	DIMENSIONS					CARTONED CUBIC	
		D	W	H	A	KW	WEIGHT	FEET
GLASS FULL EDGE MOUNT SCREEN								
¼" GLASS THICKNESS								
24" HIGH								
NAC7224PVEGP	\$ 604		72	24				
NAC6624PVEGP	565		66	24				
NAC6024PVEGP	530		60	24				
NAC5424PVEGP	489		54	24				
NAC4824PVEGP	457		48	24				
NAC2924PVSEGP	358		29	24				
NAC2324PVSEGP	321		23	24				



- Screen extends 24" above worksurface
- Size down to avoid pinch points on height adjust surfaces, as well as when both front and side screens are specified
- Fits on 1³/₁₆" and 1⁷/₁₆" worksurface thicknesses
- Bulk pack pricing available – save money and reduce onsite packing materials by choosing this option. Contact our By Design Product Modifications Team for a price quote
- Glass Thickness ¼"
- Clear Tempered Glass Screen
- Metal Edge Bracket
- Bracket ships attached to screen
- Secure under surface with screws
- Remove protective film from screen
- Attaches to the underneath side of the worksurface with fasteners – 2 people recommended for installation

FULL EDGE MOUNT SCREEN - DESKS+BENCHING

TO ORDER, SPECIFY:

1. Model Number
2. Resin Color
3. Bracket Paint Color

SAMPLE MODEL NUMBER:

NAC7224PVEP

- See page 3 for Return To Work options

	MODEL NO./DESCRIPTION	LIST PRICE	DIMENSIONS				CARTONED WEIGHT	CUBIC FEET
			D	W	H	A		
	¼" RESIN THICKNESS 24" HIGH							
	NAC7224PVEP	\$ 952		72	24			
	NAC6624PVEP	830		66	24			
	NAC6024PVEP	685		60	24			
	NAC5424PVEP	677		54	24			
	NAC4824PVEP	666		48	24			
	NAC2924PVSEP	404		29	24			
	NAC2324PVSEP	336		23	24			

- Screen extends 24" above worksurface
- Size down to avoid pinch points on height adjust surfaces, as well as when both front and side screens are specified
- Fits on 1¾" and 1⅞" worksurface thicknesses
- Bulk pack pricing available – save money and reduce onsite packing materials by choosing this option. Contact our By Design Product Modifications Team for a price quote
- Resin Thickness ¼"
- Clear or Frosted Resin Screen
- Metal Edge Bracket
- Bracket ships attached to screen
- Secure under surface with screws
- Remove protective film from screen
- Attaches to the underneath side of the worksurface with fasteners – 2 people recommended for installation

FULL EDGE MOUNT SCREEN - DESKS+BENCHING

TO ORDER, SPECIFY:

1. Model Number
2. Bracket Paint Color

SAMPLE MODEL NUMBER:

NAC7230PVEPP

- See page 3 for Return To Work options

MODEL NO./DESCRIPTION	LIST PRICE	DIMENSIONS					CARTONED WEIGHT	CUBIC FEET
		D	W	H	A	KW		
PET FULL EDGE MOUNT SCREEN								
½" PET THICKNESS								
30" HIGH								
NAC7230PVEPP	\$ 1571		72	30				
NAC6630PVEPP	1486		66	30				
NAC6030PVEPP	1426		60	30				
NAC5430PVEPP	1103		54	30				
NAC4830PVEPP	775		48	30				
NAC2930PVSEPP	696		29	30				
NAC2330PVSEPP	589		23	30				
24" HIGH								
NAC7224PVEPP	909		72	24				
NAC6624PVEPP	866		66	24				
NAC6024PVEPP	825		60	24				
NAC5424PVEPP	744		54	24				
NAC4824PVEPP	638		48	24				
NAC2924PVSEPP	451		29	24				
NAC2324PVSEPP	347		23	24				

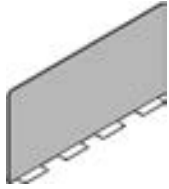

- 24"H Screen extends 24" above worksurface; 30"H Screen extends 30" above worksurface
- Size down to avoid pinch points on height adjust surfaces, as well as when both front and side screens are specified
- Fits on 1¾" and 1⅞" worksurface thicknesses
- PET Thickness ½"
- Nordic Knit PET Screen
- Metal Edge Bracket
- Bracket ships attached to screen
- Secure under surface with screws
- Remove protective film from screen
- Attaches to the underneath side of the worksurface with fasteners – 2 people recommended for installation

STATIC FLOOR SCREEN - DESKS+BENCHING

TO ORDER, SPECIFY:

1. Model Number
2. Frame Paint Color

SAMPLE MODEL NUMBERS:

NAC4872FLSGP
NAC4872FLSBP

- See page 3 for Return To Work options

	MODEL NO./DESCRIPTION	LIST PRICE	DIMENSIONS			A	KW	CARTONED WEIGHT	CUBIC FEET
			D	W	H				
	GLASS STATIC FLOOR SCREEN								
	1½" X 1½" FRAME THICKNESS								
	72" HIGH								
	NAC4872FLSGP	\$ 1884	18	48	72				
	NAC3672FLSGP	1516	18	36	72				
	NAC3072FLSGP	1429	18	30	72				
	NAC2472FLSGP	1326	18	24	72				
	60" HIGH								
	NAC4860FLSGP	\$ 1688	18	48	60				
	NAC3660FLSGP	1511	18	36	60				
NAC3060FLSGP	1332	18	30	60					
NAC2460FLSGP	1247	18	24	60					
<ul style="list-style-type: none"> • Clear Glass • Aluminum frame with flat metal feet • Clear rubber bumpers on feet • Bulk pack pricing available – save money and reduce onsite packing materials by choosing this option. Contact our By Design Product Modifications Team for a price quote • Frame Thickness 1½" x 1½" • 60" High Frame has Foot Dimensions of 18" deep x 4" wide • 72" High Frame has Foot Dimensions 19½" deep x 4" wide • Clear Tempered Glass Screen • Aluminum Painted Frame • Feet ship in box with screen unattached • Attach feet with screwdriver • 2 people recommended for installation 									

FLUTED POLYCARBONATE STATIC FLOOR SCREEN



1½" X 1½" FRAME THICKNESS								
72" HIGH								
NAC4872FLSBP	\$ 1632	18	48	72				
NAC3672FLSBP	1314	18	36	72				
NAC3072FLSBP	1281	18	30	72				
NAC2472FLSBP	1181	18	24	72				
60" HIGH								
NAC4860FLSBP	\$ 1463	18	48	60				
NAC3660FLSBP	1331	18	36	60				
NAC3060FLSBP	1202	18	30	60				
NAC2460FLSBP	1116	18	24	60				
<ul style="list-style-type: none"> • Semi-opaque fluted polycarbonate • Aluminum frame with flat metal feet • Clear rubber bumpers on feet • Bulk pack pricing available – save money and reduce onsite packing materials by choosing this option. Contact our By Design Product Modifications Team for a price quote • Frame Thickness 1½" x 1½" • 60" High Frame has Foot Dimensions of 18" deep x 4" wide • 72" High Frame has Foot Dimensions 19½" deep x 4" wide • Fluted, Semi-Opaque Polycarbonate Screen • Aluminum Painted Frame • Feet ship in box with screen unattached • Attach feet with screwdriver • 2 people recommended for installation 								

STATIC FLOOR SCREEN - DESKS+BENCHING

TO ORDER, SPECIFY:

1. Model Number
2. HPL Color
3. Frame Paint Color

SAMPLE MODEL NUMBER:

- NAC4872FLSGP
 • See page 3 for Return To Work options

MODEL NO./DESCRIPTION	LIST PRICE	DIMENSIONS			A	KW	CARTONED WEIGHT	CUBIC FEET
		D	W	H				
HPL STATIC FLOOR SCREEN								
1½" X 1½" FRAME THICKNESS								
72" HIGH								
NAC4872FLSLP	\$ 2003	18	48	72				
NAC3672FLSLP	1760	18	36	72				
NAC3072FLSLP	1622	18	30	72				
NAC2472FLSLP	1473	18	24	72				
60" HIGH								
NAC4860FLSLP	\$ 1810	18	48	60				
NAC3660FLSLP	1645	18	36	60				
NAC3060FLSLP	1480	18	30	60				
NAC2460FLSLP	1358	18	24	60				



- HPL
- Aluminum frame with flat metal feet
- Clear rubber bumpers on feet
- Bulk pack pricing available – save money and reduce onsite packing materials by choosing this option. Contact our By Design Product Modifications Team for a price quote
- Frame Thickness 1½" x 1½"
- 60" High Frame has Foot Dimensions of 18" deep x 4" wide
- 72" High Frame has Foot Dimensions 19½" deep x 4" wide
- HPL Screen
- Aluminum Painted Frame
- Feet ship in box with screen unattached
- Attach feet with screwdriver
- 2 people recommended for installation

STATIC FLOOR SCREEN - DESKS+BENCHING

TO ORDER, SPECIFY:

1. Model Number
2. Frame Paint Color

SAMPLE MODEL NUMBERS:

NAC4872FLSMP
NAC4872FLSPP

- See page 3 for Return To Work options

HPL MARKER BOARD STATIC FLOOR SCREEN



MODEL NO./DESCRIPTION	LIST PRICE	DIMENSIONS				CARTONED WEIGHT	CUBIC FEET
		D	W	H	A		
1½" X 1½" FRAME THICKNESS 72" HIGH							
NAC4872FLSMP	\$ 2003	18	48	72			
NAC3672FLSMP	1760	18	36	72			
NAC3072FLSMP	1622	18	30	72			
NAC2472FLSMP	1473	18	24	72			
60" HIGH							
NAC4860FLSMP	\$ 1810	18	48	60			
NAC3660FLSMP	1645	18	36	60			
NAC3060FLSMP	1480	18	30	60			
NAC2460FLSMP	1358	18	24	60			

- HPL Marker Board
- Aluminum frame with flat metal feet
- Clear rubber bumpers on feet
- Bulk pack pricing available – save money and reduce onsite packing materials by choosing this option. Contact our By Design Product Modifications Team for a price quote
- Frame Thickness 1½" x 1½"
- 60" High Frame has Foot Dimensions of 18" deep x 4" wide
- 72" High Frame has Foot Dimensions 19½" deep x 4" wide
- HPL Marker Board Screen
- Aluminum Painted Frame
- Feet ship in box with screen unattached
- Attach feet with screwdriver
- 2 people recommended for installation

PET STATIC FLOOR SCREEN

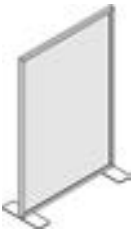

MODEL NO./DESCRIPTION	LIST PRICE	DIMENSIONS				CARTONED WEIGHT	CUBIC FEET
		D	W	H	A		
1½" X 1½" FRAME THICKNESS 72" HIGH							
NAC4872FLSPP	\$ 2490	18	48	72			
NAC3672FLSPP	2428	18	36	72			
NAC3072FLSPP	2394	18	30	72			
NAC2472FLSPP	1776	18	24	72			
60" HIGH							
NAC4860FLSPP	\$ 2417	18	48	60			
NAC3660FLSPP	2356	18	36	60			
NAC3060FLSPP	2329	18	30	60			
NAC2460FLSPP	1708	18	24	60			

- Nordic Knit PET
- Aluminum frame with flat metal feet
- Clear rubber bumpers on feet
- Frame Thickness 1½" x 1½"
- 60" High Frame has Foot Dimensions of 18" deep x 4" wide
- 72" High Frame has Foot Dimensions 19½" deep x 4" wide
- Nordic Knit PET Screen
- Aluminum Painted Frame
- Feet ship in box with screen unattached
- Attach feet with screwdriver
- 2 people recommended for installation

STATIC FLOOR SCREEN - DESKS+BENCHING

TO ORDER, SPECIFY:

1. Model Number
2. Fabric Grade / Color
3. Frame Paint Color

SAMPLE MODEL NUMBER:

NAC4872FLSPF

- See page 3 for Return To Work options

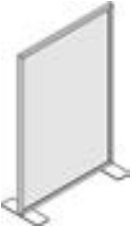
	MODEL NO./DESCRIPTION	LIST PRICE	DIMENSIONS			CARTONED WEIGHT	CUBIC FEET
			D	W	H		
TACK BOARD STATIC FLOOR SCREEN 	1½" X 1½" FRAME THICKNESS 72" HIGH	GRADE A	GRADE B/ COM				
	NAC4872FLSPF	\$ 1679	\$ 1847	18	48	72	
	NAC3672FLSPF	1542	1710	18	36	72	
	NAC3072FLSPF	1440	1608	18	30	72	
	NAC2472FLSPF	1411	1579	18	24	72	
	60" HIGH						
	NAC4860FLSPF	\$ 1596	\$ 1736	18	48	60	
	NAC3660FLSPF	1434	1574	18	36	60	
	NAC3060FLSPF	1372	1512	18	30	60	
	NAC2460FLSPF	1314	1454	18	24	60	

- Tack Board Fabric
- Aluminum frame with flat metal feet
- Clear rubber bumpers on feet
- Frame Thickness 1½" x 1½"
- 60" High Frame has Foot Dimensions of 18" deep x 4" wide
- 72" High Frame has Foot Dimensions 19½" deep x 4" wide
- Dune , Repetition (grade A), or Pact (grade B) tack board fabrics
- Aluminum Painted Frame
- Feet ship in box with screen unattached
- Attach feet with screwdriver
- 2 people recommended for installation

STATIC FLOOR SCREEN - DESKS+BENCHING

TO ORDER, SPECIFY:

1. Model Number
2. Paint Color

SAMPLE MODEL NUMBER:

NAC20FLSGBP

- See page 3 for Return To Work options

	MODEL NO./DESCRIPTION	LIST PRICE	DIMENSIONS				CARTONED CUBIC	
			D	W	H	A	KW	WEIGHT
STATIC FLOOR SCREEN GANGING BRACKET 	NAC20FLSGBP	\$ 175	6	19	1/8			
	<ul style="list-style-type: none"> • To connect 2 static floor screens together in an L, or T configuration • Bracket Thickness 1/8" • Bracket is 6" deep x 19" wide • Steel • 2 people recommended for installation 							

STATIC FLOOR SCREEN - DESKS+BENCHING

TO ORDER, SPECIFY:

1. Model Number
2. Frame Paint Color

SAMPLE MODEL NUMBERS:

NAC6072FLH30GP
NAC6072FLH30BP

• See page 3 for Return To Work options

GLASS STATIC SURFACE/FLOOR SCREEN	MODEL NO./DESCRIPTION	LIST PRICE	DIMENSIONS			A	KW	CARTONED WEIGHT	CUBIC FEET
			D	W	H				
	1½" X 1½" FRAME THICKNESS 72" HIGH								
	NAC6072FLH30GP	\$ 2071	18	60	72				
	NAC4872FLH24GP	1865	18	48	72				
	60" HIGH								
	NAC6060FLH30GP	\$ 1912	18	60	60				
	NAC4860FLH24GP	1731	18	48	60				
<ul style="list-style-type: none"> • Clear Glass • Aluminum frame with flat metal feet • Clear rubber bumpers on feet • Specify 60" Wide models with 30" deep worksurfaces (30" will overhang worksurface) • Specify 48" Wide models with 24" deep worksurfaces (24" will overhang worksurface) • Bulk pack pricing available – save money and reduce onsite packing materials by choosing this option. Contact our By Design Product Modifications Team for a price quote • Frame Thickness 1½" x 1½" • 60" High Frame has Foot Dimensions of 18" deep x 4" wide • 72" High Frame has Foot Dimensions 19½" deep x 4" wide • Clear Tempered Glass Screen • Aluminum Painted Frame • Feet ship in box with screen unattached • Attach feet with screwdriver • 2 people recommended for installation 									

**FLUTED POLYCARBONATE
STATIC SURFACE/FLOOR SCREEN**



1½" X 1½" FRAME THICKNESS 72" HIGH								
NAC6072FLH30BP	\$ 1818	18	60	72				
NAC4872FLH24BP	1464	18	48	72				
60" HIGH								
NAC6060FLH30BP	\$ 1563	18	60	60				
NAC4860FLH24BP	1371	18	48	60				
<ul style="list-style-type: none"> • Semi-opaque fluted polycarbonate • Aluminum frame with flat metal feet • Clear rubber bumpers on feet • Specify 60" Wide models with 30" deep worksurfaces (30" will overhang worksurface) • Specify 48" Wide models with 24" deep worksurfaces (24" will overhang worksurface) • Bulk pack pricing available – save money and reduce onsite packing materials by choosing this option. Contact our By Design Product Modifications Team for a price quote • Frame Thickness 1½" x 1½" • 60" High Frame has Foot Dimensions of 18" deep x 4" wide • 72" High Frame has Foot Dimensions 19½" deep x 4" wide • Fluted, Semi-Opaque Polycarbonate Screen • Aluminum Painted Frame • Feet ship in box with screen unattached • Attach feet with screwdriver • 2 people recommended for installation 								

STATIC FLOOR SCREEN - DESKS+BENCHING

TO ORDER, SPECIFY:

1. Model Number
2. HPL Color
3. Frame Paint Color

SAMPLE MODEL NUMBER:

NAC6072FLH30LP

- See page 3 for Return To Work options

MODEL NO./DESCRIPTION	LIST PRICE	DIMENSIONS				CARTONED WEIGHT	CUBIC FEET
		D	W	H	A		
HPL STATIC SURFACE/FLOOR SCREEN							
1½" X 1½" FRAME THICKNESS 72" HIGH							
NAC6072FLH30LP	\$ 2421	18	60	72			
NAC4872FLH24LP	2125	18	48	72			
60" HIGH							
NAC6060FLH30LP	\$ 2190	18	60	60			
NAC4860FLH24LP	1933	18	48	60			



- HPL
- Aluminum frame with flat metal feet
- Clear rubber bumpers on feet
- Specify 60" Wide models with 30" deep worksurfaces (30" will overhang worksurface)
- Specify 48" Wide models with 24" deep worksurfaces (24" will overhang worksurface)
- Bulk pack pricing available – save money and reduce onsite packing materials by choosing this option. Contact our By Design Product Modifications Team for a price quote
- Frame Thickness 1½" x 1½"
- 60" High Frame has Foot Dimensions of 18" deep x 4" wide
- 72" High Frame has Foot Dimensions 19½" deep x 4" wide
- HPL Screen
- Aluminum Painted Frame
- Feet ship in box with screen unattached
- Attach feet with screwdriver
- 2 people recommended for installation

STATIC FLOOR SCREEN - DESKS+BENCHING

TO ORDER, SPECIFY:

1. Model Number
2. Frame Paint Color

SAMPLE MODEL NUMBERS:

NAC6072FLH30MP
NAC6072FLH30PP

- See page 3 for Return To Work options

MODEL NO./DESCRIPTION	LIST PRICE	DIMENSIONS			A	KW	CARTONED WEIGHT	CUBIC FEET
		D	W	H				
HPL MARKER BOARD STATIC SURFACE/FLOOR SCREEN								
1½" X 1½" FRAME THICKNESS 72" HIGH								
NAC6072FLH30MP	\$ 2437	18	60	72				
NAC4872FLH24MP	2125	18	48	72				
60" HIGH								
NAC6060FLH30MP	\$ 2203	18	60	60				
NAC4860FLH24MP	1933	18	48	60				
<ul style="list-style-type: none"> • HPL Marker Board • Aluminum frame with flat metal feet • Clear rubber bumpers on feet • Specify 60" Wide models with 30" deep worksurfaces (30" will overhang worksurface) • Specify 48" Wide models with 24" deep worksurfaces (24" will overhang worksurface) • Bulk pack pricing available – save money and reduce onsite packing materials by choosing this option. Contact our By Design Product Modifications Team for a price quote • Frame Thickness 1½" x 1½" • 60" High Frame has Foot Dimensions of 18" deep x 4" wide • 72" High Frame has Foot Dimensions 19½" deep x 4" wide • HPL Marker Board Screen • Aluminum Painted Frame • Feet ship in box with screen unattached • Attach feet with screwdriver • 2 people recommended for installation 								

PET STATIC SURFACE/FLOOR SCREEN



1½" X 1½" FRAME THICKNESS 72" HIGH

NAC6072FLH30PP	\$ 2949	18	60	72
NAC4872FLH24PP	2752	18	48	72

60" HIGH

NAC6060FLH30PP	\$ 2914	18	60	60
NAC4860FLH24PP	2723	18	48	60

- PET
- Aluminum frame with flat metal feet
- Clear rubber bumpers on feet
- Specify 60" Wide models with 30" deep worksurfaces (30" will overhang worksurface)
- Specify 48" Wide models with 24" deep worksurfaces (24" will overhang worksurface)
- Frame Thickness 1½" x 1½"
- 60" High Frame has Foot Dimensions of 18" deep x 4" wide
- 72" High Frame has Foot Dimensions 19½" deep x 4" wide
- Nordic Knit PET Screen
- Aluminum Painted Frame
- Feet ship in box with screen unattached
- Attach feet with screwdriver
- 2 people recommended for installation

STATIC FLOOR SCREEN - DESKS+BENCHING

TO ORDER, SPECIFY:

1. Model Number
2. Fabric Grade / Color
3. Frame Paint Color

SAMPLE MODEL NUMBER:

NAC6072FLH30PF

- See page 3 for Return To Work options

	MODEL NO./DESCRIPTION	LIST PRICE	DIMENSIONS				CARTONED CUBIC WEIGHT	CUBIC FEET
			D	W	H	A		
TACK BOARD FABRIC STATIC SURFACE/FLOOR SCREEN	1½" X 1½" FRAME THICKNESS 72" HIGH	GRADE A	GRADE B/ COM					
	NAC6072FLH30PF	\$ 2115	\$ 2283	18	60	72		
	NAC4872FLH24PF	1811	1979	18	48	72		
	60" HIGH							
	NAC6060FLH30PF	\$ 2029	\$ 2169	18	60	60		
	NAC4860FLH24PF	1743	1883	18	48	60		



- Tack board fabric
- Aluminum frame with flat metal feet
- Clear rubber bumpers on feet
- Specify 60" Wide models with 30" deep worksurfaces (30" will overhang worksurface)
- Specify 48" Wide models with 24" deep worksurfaces (24" will overhang worksurface)
- Frame Thickness 1½" x 1½"
- 60" High Frame has Foot Dimensions of 18" deep x 4" wide
- 72" High Frame has Foot Dimensions 19½" deep x 4" wide
- Dune, Repetition (grade A), or Pact (grade B) tack board fabrics
- Aluminum Painted Frame
- Feet ship in box with screen unattached
- Attach feet with screwdriver
- 2 people recommended for installation

MOBILE FLOOR SCREEN - DESKS+BENCHING

TO ORDER, SPECIFY:

1. Model Number
2. Frame Paint Color

SAMPLE MODEL NUMBERS:

NAC4872FLMGP
NAC4872FLMBP

- See page 3 for Return To Work options

GLASS MOBILE FLOOR SCREEN	MODEL NO./DESCRIPTION	LIST PRICE	DIMENSIONS				CARTONED WEIGHT	CUBIC FEET
			D	W	H	A		
	1½" X 1½" FRAME THICKNESS							
	74% HIGH							
	NAC4872FLMGP	\$ 2008	18	48	74%			
	NAC3672FLMGP	1779	18	36	74%			
	NAC3072FLMGP	1548	18	30	74%			
	NAC2472FLMGP	1446	18	24	74%			
	62% HIGH							
	NAC4860FLMGP	\$ 1809	18	48	62%			
	NAC3660FLMGP	1631	18	36	62%			
	NAC3060FLMGP	1452	18	30	62%			
	NAC2460FLMGP	1367	18	24	62%			
	<ul style="list-style-type: none"> • Clear Glass • Aluminum frame with flat metal feet with locking 1½" diameter caster • Bulk pack pricing available – save money and reduce onsite packing materials by choosing this option. Contact our By Design Product Modifications Team for a price quote • Frame Thickness 1½" x 1½" • 60" high Frame is 62% high with casters (Foot Dimension 18" deep x 4" wide) • 72" high Frame is 74% high with casters (Foot Dimension 19½" deep x 4" wide) • Clear Tempered Glass Screen • Aluminum Painted Frame • Feet ship in box with screen unattached • Attach feet with screwdriver • 2 people recommended for installation 							

FLUTED POLYCARBONATE MOBILE FLOOR SCREEN



	1½" X 1½" FRAME THICKNESS							
	74% HIGH							
	NAC4872FLMBP	\$ 1738	18	48	74%			
	NAC3672FLMBP	1570	18	36	74%			
	NAC3072FLMBP	1402	18	30	74%			
	NAC2472FLMBP	1300	18	24	74%			
	62% HIGH							
	NAC4860FLMBP	\$ 1580	18	48	62%			
	NAC3660FLMBP	1451	18	36	62%			
	NAC3060FLMBP	1321	18	30	62%			
	NAC2460FLMBP	1234	18	24	62%			
	<ul style="list-style-type: none"> • Semi-opaque fluted polycarbonate • Aluminum frame with flat metal feet with locking 1½" diameter caster • Bulk pack pricing available – save money and reduce onsite packing materials by choosing this option. Contact our By Design Product Modifications Team for a price quote • Frame Thickness 1½" x 1½" • 60" high Frame is 62% high with casters (Foot Dimension 18" deep x 4" wide) • 72" high Frame is 74% high with casters (Foot Dimension 19½" deep x 4" wide) • Fluted, Semi-Opaque Polycarbonate Screen • Aluminum Painted Frame • Feet ship in box with screen unattached • Attach feet with screwdriver • 2 people recommended for installation 							

MOBILE FLOOR SCREEN - DESKS+BENCHING

TO ORDER, SPECIFY:

1. Model Number
2. HPL Color
3. Frame Paint Color

SAMPLE MODEL NUMBER:

NAC4872FLMLP

- See page 3 for Return To Work options

MODEL NO./DESCRIPTION	LIST PRICE	DIMENSIONS				KW	CARTONED WEIGHT	CUBIC FEET
		D	W	H	A			
HPL MOBILE FLOOR SCREEN								
1½" X 1½" FRAME THICKNESS 74%" HIGH								
NAC4872FLMLP	\$ 2123	18	48	74%				
NAC3672FLMLP	1933	18	36	74%				
NAC3072FLMLP	1741	18	30	74%				
NAC2472FLMLP	1593	18	24	74%				
62%" HIGH								
NAC4860FLMLP	\$ 1930	18	48	62%				
NAC3660FLMLP	1765	18	36	62%				
NAC3060FLMLP	1601	18	30	62%				
NAC2460FLMLP	1478	18	24	62%				



- HPL
- Aluminum frame with flat metal feet with locking 1½" diameter caster
- Bulk pack pricing available – save money and reduce onsite packing materials by choosing this option. Contact our By Design Product Modifications Team for a price quote
- Frame Thickness 1½" x 1½"
- 60" high Frame is 62%" high with casters (Foot Dimension 18" deep x 4" wide)
- 72" high Frame is 74%" high with casters (Foot Dimension 19½" deep x 4" wide)
- HPL Screen
- Aluminum Painted Frame
- Feet ship in box with screen unattached
- Attach feet with screwdriver
- 2 people recommended for installation

MOBILE FLOOR SCREEN - DESKS+BENCHING

TO ORDER, SPECIFY:

1. Model Number
2. Frame Paint Color

SAMPLE MODEL NUMBERS:

NAC4872FLMMP
NAC4872FLMPP

- See page 3 for Return To Work options

MODEL NO./DESCRIPTION	LIST PRICE	DIMENSIONS				CARTONED WEIGHT	CUBIC FEET
		D	W	H	A KW		
HPL MARKER BOARD MOBILE FLOOR SCREEN							
1½" X 1½" FRAME THICKNESS 74¾" HIGH							
NAC4872FLMMP	\$ 2123	18	48	74¾"			
NAC3672FLMMP	1933	18	36	74¾"			
NAC3072FLMMP	1741	18	30	74¾"			
NAC2472FLMMP	1593	18	24	74¾"			
62¾" HIGH							
NAC4860FLMMP	\$ 1930	18	48	62¾"			
NAC3660FLMMP	1765	18	36	62¾"			
NAC3060FLMMP	1601	18	30	62¾"			
NAC2460FLMMP	1478	18	24	62¾"			

- HPL Marker Board
- Aluminum frame with flat metal feet with locking 1¾" diameter caster
- Bulk pack pricing available – save money and reduce onsite packing materials by choosing this option. Contact our By Design Product Modifications Team for a price quote
- Frame Thickness 1½" x 1½"
- 60" high Frame is 62¾" high with casters (Foot Dimension 18" deep x 4" wide)
- 72" high Frame is 74¾" high with casters (Foot Dimension 19½" deep x 4" wide)
- HPL Marker Board Screen
- Aluminum Painted Frame
- Feet ship in box with screen unattached
- Attach feet with screwdriver
- 2 people recommended for installation

PET MOBILE FLOOR SCREEN

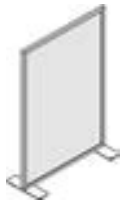

MODEL NO./DESCRIPTION	LIST PRICE	DIMENSIONS				CARTONED WEIGHT	CUBIC FEET
		D	W	H	A KW		
1½" X 1½" FRAME THICKNESS 72" HIGH							
NAC4872FLMPP	\$ 2615	18	48	72"			
NAC3672FLMPP	2553	18	36	72"			
NAC3072FLMPP	2520	18	30	72"			
NAC2472FLMPP	1901	18	24	72"			
60" HIGH							
NAC4860FLMPP	\$ 2543	18	48	60"			
NAC3660FLMPP	2482	18	36	60"			
NAC3060FLMPP	2455	18	30	60"			
NAC2460FLMPP	1833	18	24	60"			

- Nordic Knit PET
- Aluminum frame with flat metal feet with locking 1¾" diameter caster
- Frame Thickness 1½" x 1½"
- 60" high Frame has 18" deep x 4" wide feet with casters
- 72" high Frame has 19½" deep x 4" wide feet with casters
- Nordic Knit PET Screen
- Aluminum Painted Frame
- Feet ship in box with screen unattached
- Attach feet with screwdriver
- 2 people recommended for installation

MOBILE FLOOR SCREEN - DESKS+BENCHING

TO ORDER, SPECIFY:

1. Model Number
2. Fabric Grade / Color
3. Frame Paint Color

SAMPLE MODEL NUMBER:

NAC4872FLMPF

- See page 3 for Return To Work options

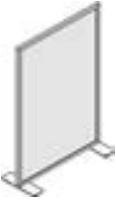
	MODEL NO./DESCRIPTION	LIST PRICE	DIMENSIONS			A	KW	CARTONED WEIGHT	CUBIC FEET
			D	W	H				
TACK BOARD FABRIC MOBILE FLOOR SCREEN 	1½" X 1½" FRAME THICKNESS 72" HIGH	GRADE A	GRADE B/ COM						
	NAC4872FLMPF	\$ 1804	\$ 1972	18	48	72			
	NAC3672FLMPF	1668	1836	18	36	72			
	NAC3072FLMPF	1565	1733	18	30	72			
	NAC2472FLMPF	1538	1706	18	24	72			
	60" HIGH								
	NAC4860FLMPF	\$ 1722	\$ 1862	18	48	60			
	NAC3660FLMPF	1561	1701	18	36	60			
	NAC3060FLMPF	1497	1637	18	30	60			
	NAC2460FLMPF	1441	1581	18	24	60			

- Tack board fabric
- Aluminum frame with flat metal feet with locking 1½" diameter caster
- Frame Thickness 1½" x 1½"
- 60" high Frame has 18" deep x 4" wide feet with casters
- 72" high Frame has 19½" deep x 4" wide feet with casters
- Dune, Repetition (grade A), or Pact (grade B) tack board fabrics
- Aluminum Painted Frame
- Feet ship in box with screen unattached
- Attach feet with screwdriver
- 2 people recommended for installation

UNIVERSAL PANEL MOUNT PRIVACY SCREEN - DESKS+BENCHING

TO ORDER, SPECIFY:

1. Model Number
2. Resin Color

SAMPLE MODEL NUMBER:

NAC4818PVUPR

- See page 3 for Return To Work options

	MODEL NO./DESCRIPTION	LIST PRICE	DIMENSIONS					CARTONED CUBIC	
			D	W	H	A	KW	WEIGHT	FEET
BASIC SCREEN WITH UNIVERSAL BRACKET - RESIN: FOR 3/4"; 1 1/2" - 2 1/2" THICK PANELS	1/4" RESIN THICKNESS								
	18" HIGH								
	NAC4818PVUPR	\$ 582	48	18					
	NAC4218PVUPR	574	42	18					
	NAC3618PVUPR	478	36	18					
	NAC3018PVUPR	451	30	18					
	NAC2418PVUPR	389	24	18					



- Universal bracket is silver
- Resin available in Clear or Frosted with radiused corners
- Fits on 3/4"; 1 1/2" - 2 1/2" panel thicknesses. Use included spacers for secure fit. Spacers not recommended for field cut
- Bulk pack pricing available – save money and reduce onsite packing materials by choosing this option. Contact our By Design Product Modifications Team for a price quote
- Resin Thickness 1/4"
- Clear or Frosted Resin Screen
- Metal Mounting Bracket
- Brackets ship in box with screen
- Remove protective film from screen
- Will require attachment to panel with fasteners – 2 people recommended for installation

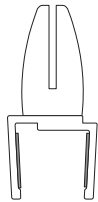

Use one 1/8" foam pad per side for 1 1/2" to 2 1/2" thick panels

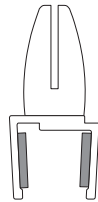

Use one 1/4" foam pad per side for 1" to 1 1/2" thick panels

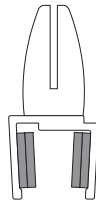

Use two 1/4" foam pads per side for 3/4" to 1" thick panels

UNIVERSAL PANEL MOUNT PRIVACY SCREEN - DESKS+C2NG

TO ORDER, SPECIFY:

1. Model Number
2. Resin Color

SAMPLE MODEL NUMBER:

NAC4818PVUP3R

- See page 3 for Return To Work options

	MODEL NO./DESCRIPTION	LIST PRICE	DIMENSIONS			CARTONED CUBIC		
			D	W	H	A	KW	WEIGHT
BASIC SCREEN WITH UNIVERSAL BRACKET - RESIN: FOR 2½" - 3½" THICK PANELS	⅜" RESIN THICKNESS 18" HIGH							
	NAC4818PVUP3R	\$ 719		48	18			
	NAC4218PVUP3R	703		42	18			
	NAC3618PVUP3R	569		36	18			
	NAC3018PVUP3R	512		30	18			
	NAC2418PVUP3R	421		24	18			



- Universal bracket is silver
- Resin available in Clear or Frosted with radiused corners
- Fits on 2½" – 3½" panel thicknesses. Use included spacers for secure fit
- Resin Thickness ⅜"
- Clear or Frosted Resin Screen
- Metal Mounting Bracket
- Brackets ship in box with screen
- Remove protective film from screen
- Will require attachment to panel with fasteners – 2 people recommended for installation

UNIVERSAL PANEL MOUNT PRIVACY SCREEN - DESKS+BENCHING

TO ORDER, SPECIFY:

1. Model Number

SAMPLE MODEL NUMBER:

NAC4818PVUPG

• See page 3 for Return To Work options

	MODEL NO./DESCRIPTION	LIST PRICE	DIMENSIONS					CARTONED CUBIC	
			D	W	H	A	KW	WEIGHT	FEET
BASIC SCREEN WITH UNIVERSAL BRACKET - GLASS: FOR 3/4"; 1 1/2" - 2 1/2" THICK PANELS	1/4" GLASS THICKNESS 18" HIGH								
	NAC4818PVUPG	\$ 488		48	18				
	NAC4218PVUPG	453		42	18				
	NAC3618PVUPG	417		36	18				
	NAC3018PVUPG	382		30	18				
	NAC2418PVUPG	346		24	18				



- Universal bracket is silver
- Fits on 3/4"; 1 1/2" - 2 1/2" panel thicknesses. Use included spacers for secure fit. Spacers not recommended for field cut
- Bulk pack pricing available – save money and reduce onsite packing materials by choosing this option. Contact our By Design Product Modifications Team for a price quote
- Glass Thickness 1/4"
- Clear Glass Screen
- Metal Mounting Bracket
- Brackets ship in box with screen
- Remove protective film from screen
- Will require attachment to panel with fasteners – 2 people recommended for installation

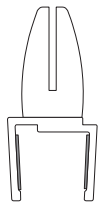

Use one 3/8" foam pad per side for 1 1/2" to 2 1/2" thick panels

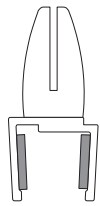

Use one 1/4" foam pad per side for 1" to 1 1/2" thick panels

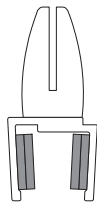

Use two 1/4" foam pads per side for 3/4" to 1" thick panels

UNIVERSAL PANEL MOUNT PRIVACY SCREEN - DESKS+C2NG

TO ORDER, SPECIFY:

1. Model Number
2. Glass

SAMPLE MODEL NUMBER:

NAC4818PVUP3G

- See page 3 for Return To Work options

	MODEL NO./DESCRIPTION	LIST PRICE	DIMENSIONS					CARTONED WEIGHT	CUBIC FEET
			D	W	H	A	KW		
BASIC SCREEN WITH UNIVERSAL BRACKET - GLASS: FOR 2½" - 3½" THICK PANELS	¼" GLASS THICKNESS 18" HIGH								
	NAC4818PVUP3G	\$ 521		48	18				
	NAC4218PVUP3G	485		42	18				
	NAC3618PVUP3G	444		36	18				
	NAC3018PVUP3G	404		30	18				
	NAC2418PVUP3G	368		24	18				



- Universal bracket is silver
- Fits on 2½" – 3½" panel thicknesses. Use included spacers for secure fit
- Glass Thickness ¼"
- Clear Glass Screen
- Metal Mounting Bracket
- Brackets ship in box with screen
- Remove protective film from screen
- Will require attachment to panel with fasteners – 2 people recommended for installation

WALL EQUIPMENT RAIL - ACCESSORIES

TO ORDER, SPECIFY:

1. Model Number

SAMPLE MODEL NUMBER:

NAC48ER

• See page 3 for Return To Work options

	MODEL NO./DESCRIPTION	LIST PRICE	DIMENSIONS			CARTONED CUBIC	
			D	W	H	A	KW
WALL ACCESSORY RAIL 	NAC48ER	\$ 530	1	48¼	1		
	NAC42ER	511	1	42¼	1		
	NAC36ER	442	1	36¼	1		
	NAC30ER	426	1	30¼	1		
	NAC24ER	354	1	24¼	1		
	NAC18ER	338	1	18¼	1		

- Attaches to architectural wall to hold accessories
- 18" - 48" rail lengths available
- Extruded Aluminum rail with Silver inlay
- Predrilled mounting holes
- Two friction-fit injection molded thermoplastic end caps
- Will require attachment to wall with fasteners - 2 people recommended for installation

ADD-ONS FOR WALL EQUIPMENT RAIL - ACCESSORIES

TO ORDER, SPECIFY:

1. Model Number

SAMPLE MODEL NUMBER:

NAC1ERKWSD

• See page 3 for Return To Work options

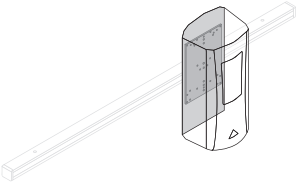
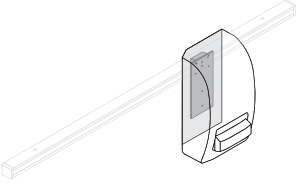
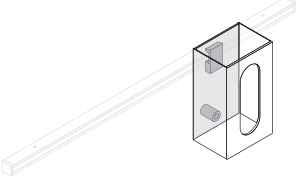
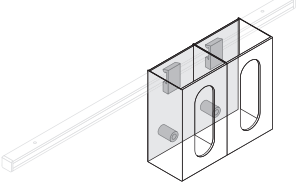
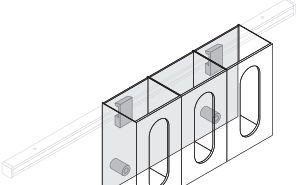
	MODEL NO./DESCRIPTION	LIST PRICE	DIMENSIONS				CARTONED WEIGHT	CUBIC FEET
			D	W	H	A KW		
MOUNTING KIT FOR WIDE-BODY SOAP/SANITIZER DISPENSER 	NAC1ERKWSD	\$ 523	¾	5	7			
	<ul style="list-style-type: none"> • Designed to hold most wide-body soap or sanitizer dispenser • Dispenser is not included 							
MOUNTING KIT FOR NARROW-BODY SOAP/SANITIZER DISPENSER 	NAC1ERKNSD	\$ 477	¾	5	4¼			
	<ul style="list-style-type: none"> • Designed to hold most narrow-body soap or sanitizer dispenser • Dispenser is not included 							
SINGLE UNIVERSAL GLOVE BOX HOLDER 	NAC1ERGV1	\$ 796	5	5¾	10			
	<ul style="list-style-type: none"> • Holds one glove box • Clear acrylic 							
DOUBLE UNIVERSAL GLOVE BOX HOLDER 	NAC1ERGV2	\$ 900	5	16¼	10			
	<ul style="list-style-type: none"> • Holds two glove boxes • Clear acrylic 							
TRIPLE UNIVERSAL GLOVE BOX HOLDER 	NAC1ERGV3	\$ 1037	5	11¼	10			
	<ul style="list-style-type: none"> • Holds three glove boxes • Clear acrylic 							

ADD-ONS FOR WALL EQUIPMENT RAIL - ACCESSORIES

TO ORDER, SPECIFY:

1. Model Number

SAMPLE MODEL NUMBER:

NAC14ERKPPD

• See page 3 for Return To Work options

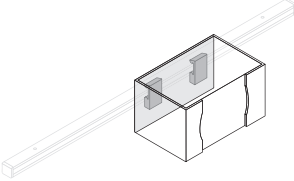
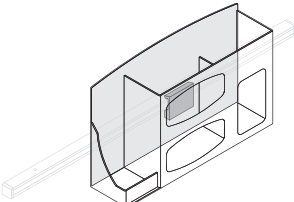
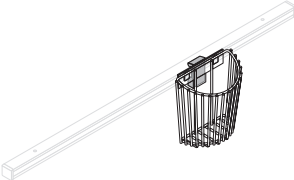
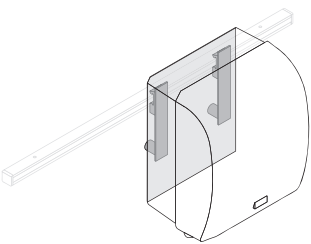
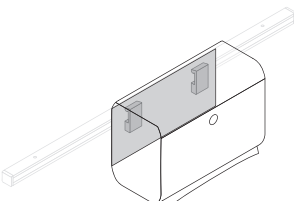
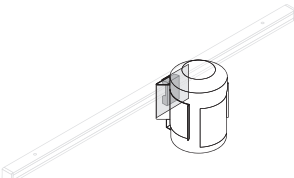
	MODEL NO./DESCRIPTION	LIST PRICE	DIMENSIONS			CARTONED CUBIC	
			D	W	H	A	KW
SMALL PPE DISPENSER  <ul style="list-style-type: none"> • Universal small box dispenser for shoe cover, cap and other items • Horizontal top feed or vertical side feed application 	NAC14ERKPPD	\$ 888	7	13¾	5¾		
PPE DISPENSER CABINET  <ul style="list-style-type: none"> • Holds 2 boxes of gloves, 1 box of face masks and 1 hand sanitizer bottle • Horizontal top feed application 	NAC19ERKPPDC	\$ 1053	4½	18½	11½		
U-SHAPED WIRE BASKET  <ul style="list-style-type: none"> • Plastic coated wire • Holds blood pressure cuff and other accessories 	NAC07ERKUWB	\$ 620	4	6¾	7		
MOUNTING KIT FOR PAPER TOWEL DISPENSER  <ul style="list-style-type: none"> • Designed to hold most paper towel dispensers • Includes stand-off bracket • Dispenser is not included 	NAC1ERKSPTD	\$ 614	¾	5	7		
MOUNTING KIT FOR TRI-FOLD PAPER TOWEL DISPENSER  <ul style="list-style-type: none"> • Designed to hold most tri-fold dispensers • Dispenser is not included 	NAC1ERKTPTD	\$ 477	¾	6	2¾		
WIPE HOLDER  <ul style="list-style-type: none"> • For most brands of sanitizing wipes • Also fits some industrial style spray bottles 	NAC1ERKWPH	\$ 700	5	5	6		

ALLOY MID-SUPPORT PANELS - DESKS+BENCHING

TO ORDER, SPECIFY:

1. Model Number

SAMPLE MODEL NUMBER:

71N6046SMSAL

• See page 3 for Return To Work options

ALLOY MID-SUPPORT PANEL	MODEL NO./DESCRIPTION	LIST PRICE	DIMENSIONS					CARTONED CUBIC WEIGHT	CUBIC FEET
			D	W	H	A	KW		
	71N6046SMSAL	\$ 781		60	46				
	71N4846SMSAL	748		48	46				
	71N2946SMSAL	476		29	46				
	71N2346SMSAL	442		23	46				
	71N3246SMSAL	476		32	46				
	71N2646SMSAL	442		26	46				
	71N6046SMSFL	577		60	46				
	71N4846SMSFL	544		48	46				
	71N3246SMSFL	271		32	46				
	71N3046SMSFL	271		30	46				
	71N2646SMSFL	238		26	46				
	71N2446SMSFL	238		24	46				
	71NGBDMA21	64							
	71NGBDMA22	64							
	71NGBDMA23	64							
	71NGBSMA21	306							
	71NGBSMA22	306							
	71NGBSMA23	306							
	71NGBSMF21	101							
	71NGBSMF22	101							
	71NGBSMF23	101							
	71N24ELJ	77							
	71N24ELJ8	125							

- Similar to existing Alloy end panels, these new mid-support panels create separation between users, side to side
- Intended for new product installations, as well as retrofitting of existing installations
- Accommodates double sided and single sided models
- Can be used with height adjustable and freestanding models, does not apply to starter, mid, and ender models
- New jumper size added to support use with mid-support panels
- New ganging | cover brackets offered in silver, black, and white
- 48" - 60" Wide x 46" High Double Sided
- 24" - 30" Wide x 46" High Single Sided
- HPL Laminate
- Medium level of complexity - these would require a 2 person installation