

1
1 PC

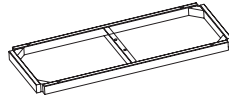

2
1 PC



3
1 PC

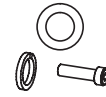

4
M8 X 75
8 PCS

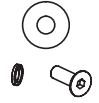

5
M6 X 50
6 PCS

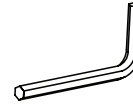

4MM
1 PC

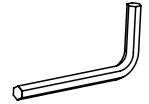

6MM
1 PC

STEP 01

SECURE LEG (3) TO SURFACE STRUCTURE (2) WITH TWO SCREWS AND WASHERS (4) WITH 6MM ALLEN KEY. REPEAT FOR EACH LEG.

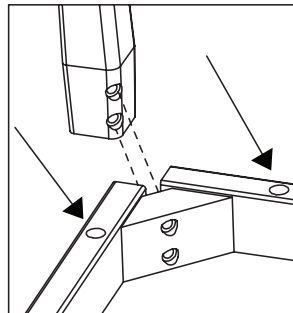
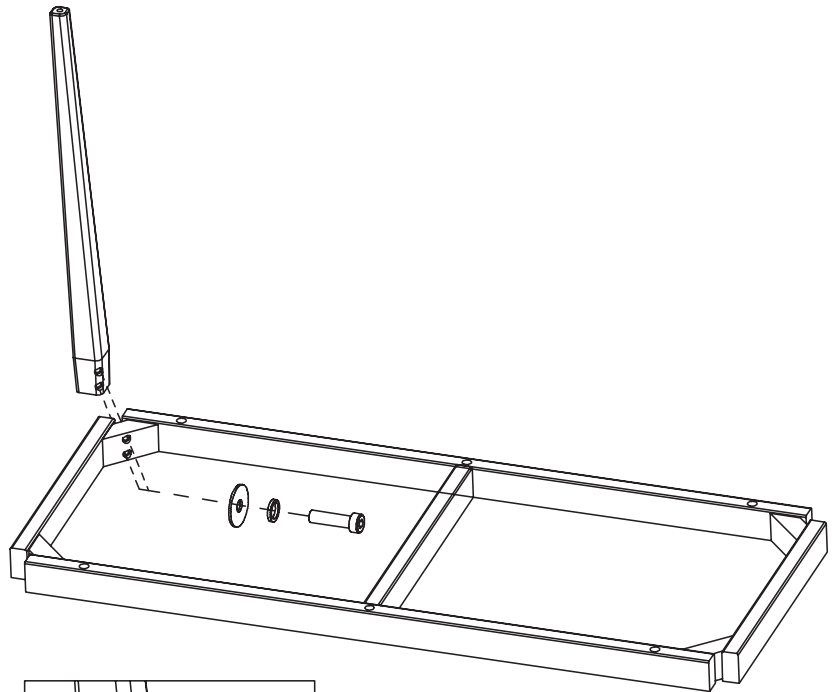

WHILE ASSEMBLING LEGS, MAKE SURE THAT HOLES FOR STEP TWO LINE UP.

STEP 02

SECURE COMPLETE STRUCTURE (2)
AND LEGS (3) TO SURFACE (1) WITH
SIX SCREWS AND WASHERS (5)
WITH 4MM ALLEN KEY.

